

Appendix A.7.3

BD02 Galway Racecourse Tunnel

A.7.3

Galway County Council
N6 Galway City Transport Project
Galway Racecourse Tunnel
Preliminary Design Report

GCOB-4.04-020-009

Issue 3 | 23 October 2017

This report takes into account the particular instructions and requirements of our client.

It is not intended for and should not be relied upon by any third party and no responsibility is undertaken to any third party.

Job number 233985







Ove Arup & Partners Ireland Ltd

Corporate House
City East Business Park
Ballybrit
Galway
H91 K5YD
Ireland

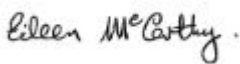
ARUP

Document Verification

ARUP

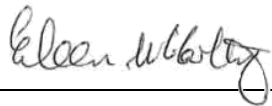
Job title		N6 Galway City Transport Project		Job number		233985	
Document title		Galway Racecourse Tunnel Preliminary Design Report		File reference		GCOB-4.04-020-009	
Document ref		GCOB-4.04-020-009					
Revision	Date	Filename	GCOB-4.04-20-009 (Galway Racecourse PDR)_Issue 1.docx				
Issue 1	16 Jan 2017	Description	For Issue 1				
			Prepared by	Checked by	Approved by		
		Name	Jennifer Keenahan/Reamonn MacReamoinn	Pat Moore	Eileen McCarthy		
		Signature					
Issue 2	02 June 2017	Filename	For Issue 2				
		Description					
			Prepared by	Checked by	Approved by		
		Name	Yalda Acar	Pat Moore	Eileen McCarthy		
Signature							
Issue 3	23 Oct 2017	Filename	GCOB-4.04-20-009 (Galway Racecourse PDR)_Issue 3.docx				
		Description	Issue 3				
			Prepared by	Checked by	Approved by		
		Name	Yalda Acar	Pat Moore	Eileen McCarthy		
Signature							
		Filename					
		Description					
			Prepared by	Checked by	Approved by		
		Name					
		Signature					

Issue Document Verification with Document



Contents

	Page
1 Introduction	1
1.1 Overview	1
1.2 Project background information	1
1.3 Previous studies and their recommendations	3
2 Site and function	5
2.1 Site location	5
2.2 Function of the structure and obstacles crossed	5
2.3 Choice of location	6
2.4 Site description and topography	6
2.5 Vertical and horizontal alignments	6
2.6 Cross sectional dimensions	6
2.7 Existing services	8
2.8 Geotechnical summary	9
2.9 Hydrogeology	11
2.10 Archaeological summary	13
2.11 Ecology summary	13
2.12 Environmental summary	13
2.13 Sustainability	13
2.14 Tunnel Structure details	14
2.15 Accommodation of M&E services in the tunnel	14
2.16 Location of the tunnel services, monitoring and maintenance building	17
3 Structure and aesthetics	19
3.1 General description of recommended structure	19
3.2 Aesthetic considerations	20
3.3 Proposals for the recommended structure	20
3.4 Description of tunnel traffic and road geometry	23
3.5 Accommodation of M&E services	24
3.6 Emergency communication, escape facilities, fire points, cross passages	24
3.7 Specific drainage details	24
3.8 Environmental conditions within the tunnel service, monitoring and maintenance building	26
3.9 Ventilation in the TSB	26
3.10 M&E elements of drainage in the TSB	27
3.11 Electrical services in the TSB	27
3.12 Tunnel fire safety	33

	3.13	Tunnel operation and plant control	37
4		Safety	38
	4.1	Traffic management during construction including land for temporary diversions	38
	4.2	Safety during construction	38
	4.3	Safety in use	38
	4.4	Lighting	38
	4.5	Protection of tunnel roof	39
	4.6	Compliance with EU road tunnel safety directive	39
	4.7	Communications and traffic control	40
5		Cost	48
	5.1	Budget estimate in current year, including whole life	48
6		Design assessment criteria	49
	6.1	Normal loading	49
	6.2	Abnormal loading	49
	6.3	Footway live loading	49
	6.4	Provision for exceptional abnormal loads	49
	6.5	Any special loading not covered above	49
	6.6	Heavy or high load route requirements and arrangements being made to preserve route	49
	6.7	Minimum headroom provided	49
	6.8	Authorities consulted and any special conditions required	49
7		Ground conditions	51
	7.1	Geotechnical compatibility with proposed foundation design	51
	7.2	Hydrogeological compatibility with proposed foundation design	52
8		Drawings and documents	53
	8.1	List of all documents accompanying the submission	53

Appendices

Appendix A

Drawings

Appendix B

Geotechnical factual report

1 Introduction

1.1 Overview

Galway County Council, Galway City Council, Transport Infrastructure Ireland (TII) (formerly NRA)¹ and the National Transport Authority are collaborating to develop a solution to the existing transportation issues in Galway City and its environs. The solution will include a smart mobility component, public transport component and a road component. The N6 Galway City Ring Road (N6 GCRR) is the road component.

As part of the N6 GCRR there are a number of structures envisaged. This report presents the preliminary design of the Galway Racecourse Tunnel (Structure S14/02) in accordance with the guidelines detailed within TII DN-STR-03001 (formally BD02). The Galway Racecourse Tunnel is envisaged so as to preserve the operability and functionality of Galway Racecourse.

1.2 Project background information

The N6 Galway City Outer Bypass, an earlier scheme, was previously developed and submitted to An Bord Pleanála (ABP) for approval on 1 December 2006. A brief summary of its history is outlined below.

On 28 November 2008, ABP delivered its decision in respect of the 2006 GCOB. ABP considered that the need for an outer bypass of Galway City connecting the existing N6 on the east to the R336 Coast Road on the west as an essential part of the strategic transport network of the Galway area had been established.

ABP granted approval for the eastern part of the scheme, the section from the N59 Moycullen Road east to the existing N6, inclusive of both junctions at the N59 Moycullen Road and the existing N6. In its decision, ABP noted its consideration of all data presented and granted approval as it considered that the part of the road development being approved would be an appropriate solution to the identified traffic needs of the city and surrounding area. ABP noted that there would be a localised severe impact on the Lough Corrib candidate Special Area of Conservation (cSAC)².

However, ABP was not satisfied with the western section of scheme between the N59 Moycullen Road and R336 Coast Road which passed through Tonabrocky Bog. Tonabrocky Bog is:

- part of the Moycullen Bogs Natural Heritage Area (NHA)

¹ The Minister for Transport, Tourism and Sport signed the order for the merger of the National Roads Authority (NRA) with the Railway Procurement Agency (RPA) to establish a single new entity called Transport Infrastructure Ireland (TII). The National Roads Authority is known as Transport Infrastructure Ireland (TII) since 1 August 2015.

² Reference ABP decision 07.ER.2056

- an active Blanket bog listed as a priority habitat in Annex I of the EU Habitats Directive
- the site of a population of Slender cotton grass which is a legally protected and vulnerable species

ABP refused permission for the western section of the scheme between the N59 Moycullen Road and R336 Coast Road on the basis that this part of the road development would not be in accordance with the preservation of the Tonabrocky Bog habitat given the potential for significant adverse effects on the environment and that less damaging alternatives may be available³.

An application was made by a third party to the High Court seeking leave to issue judicial review proceedings against the ABP decision which granted approval of the eastern section of the 2006 GCOB under Article 6(3) of the Habitats Directive (92/43/EEC), as amended. The basis for the request for a review was that ABP had erred in its interpretation of Article 6 of the Habitats Directive (92/43/EEC), as amended, in arriving at the conclusion that the effect of the 2006 GCOB road scheme on the Lough Corrib cSAC designated site would not constitute an adverse effect on the integrity of the site.

The High Court undertook a judicial review of the ABP decision. The High Court decision of 9 October 2009 upheld ABP's decision to approve the eastern part of the scheme. On 6 November 2009, the third party was granted leave to appeal to the Supreme Court against the High Court decision of 9 October 2009. The Supreme Court sought the opinion of the Court of Justice of the European Union (CJEU) on an interpretation of the Habitats Directive.

The opinion of the CJEU was delivered on the 11 April 2013 (Case C-258/11). The opinion concluded on two significant points:

- The 2006 GCOB would have an adverse effect on the integrity of the Lough Corrib cSAC due to the removal of 1.47ha of Limestone pavement (a habitat type for which the cSAC was selected)
- Given that the 2006 GCOB would have an adverse effect on the integrity of the cSAC, the proposed scheme could not be authorised under Article 6(3) of the Habitats Directive. It could only be authorised under Article 6(4) of the Habitats Directive

The CJEU opinion (i.e. Case C-258/11) established that the loss of a relatively small area of Priority Annex I habitat, where it is a habitat for which the Lough Corrib cSAC is selected, would adversely affect the integrity of the Lough Corrib cSAC and that the provisions of Article 6(4) must apply in granting consent for the project i.e.

6(4) "If, in spite of a negative assessment of the implications for the site and in the absence of alternative solutions, a plan or project must nevertheless be carried out for imperative reasons of overriding public interest, including those of a social or economic nature, the Member State shall take all compensatory measures necessary to ensure that the overall coherence of Natura 2000 is protected. It shall inform the Commission of the compensatory measures adopted".

Following receipt of the CJEU opinion, the Supreme Court quashed the earlier ABP decision to grant approval of the eastern section of the 2006 GCOB under Article 6(3) of the Habitats Directive, as amended.

As the decision of the Supreme Court was that the original 2006 GCOB scheme could not be granted approval per Article 6(3) of the Habitats Directive, the next recourse to secure planning was to advance the scheme under Article 6(4) of the Habitats Directive. Having reviewed the requirements of Article 6(4), it was decided to reassess the work to date to ensure that all possible alternatives were investigated in advance of proceeding under Article 6(4). Therefore, the process of developing a transportation solution for Galway City and its environs had to recommence from the start at Phase 1, feasibility and concept stage, to ensure that all possible alternatives were fully investigated.

1.3 Previous studies and their recommendations

Following on from the initial feasibility studies, a suitable scheme study area was determined. Thereafter, the constraints study and route selection process commenced.

Key constraints were identified and examined. These included:

- The physical form of the city with the limited space available between Lough Corrib and Galway Bay.
- Established communities, commercial and educational facilities.
- Natura 2000 designated sites and Natural Heritage Areas.
- Sites of significant architectural and cultural heritage significance.

Taking cognisance of the judgement of the 2006 GCOB scheme, the Lough Corrib candidate Special Area of Conservation and the key constraints including those listed above, Route Options were developed for further assessment. These options comprised on-line options including an upgrade of existing infrastructure, partial on-line/off-line options and new construction off-line. These options were developed and agreed with TII and refined following public consultation and further studies.

A systematic assessment of these options was undertaken which led to the selection of the Emerging Preferred Route Corridor (EPRC) for the road component and this was published in May 2015. Full details of the route option selection process are outlined in the Route Selection Report for the proposed road development.

Previous studies and documents relevant to this Preliminary Design Report are listed below.

- Galway County Council. Project Brief. Phase 1, Scheme Concept and Feasibility Studies (REF/14/11222, 2 May 2015).
- Galway County Council. Project Brief. Phase 2, Route Selection (REF/14/11222, 6 November 2015).

- GCOB-4.04-009 Route Selection Report, Issue 1, March 2016.
- Galway Transport Strategy, An Integrated Transport Management Programme for Galway City and environs, Technical Report, September 2016
- GCOB-4.04-20-005, Galway Racecourse Tunnel Options Report, Issue 1, 27/10/2016

2 Site and function

2.1 Site location

The mainline of the proposed road development passes through the northern corner of Galway Racecourse, north of the racetrack, in the vicinity of the existing stables. Galway Racecourse is home to the Galway horse racing festivals and is located in Ballybrit approximately 4km to the north east of Galway City.

Figure 2.1: Galway Racecourse tunnel site location

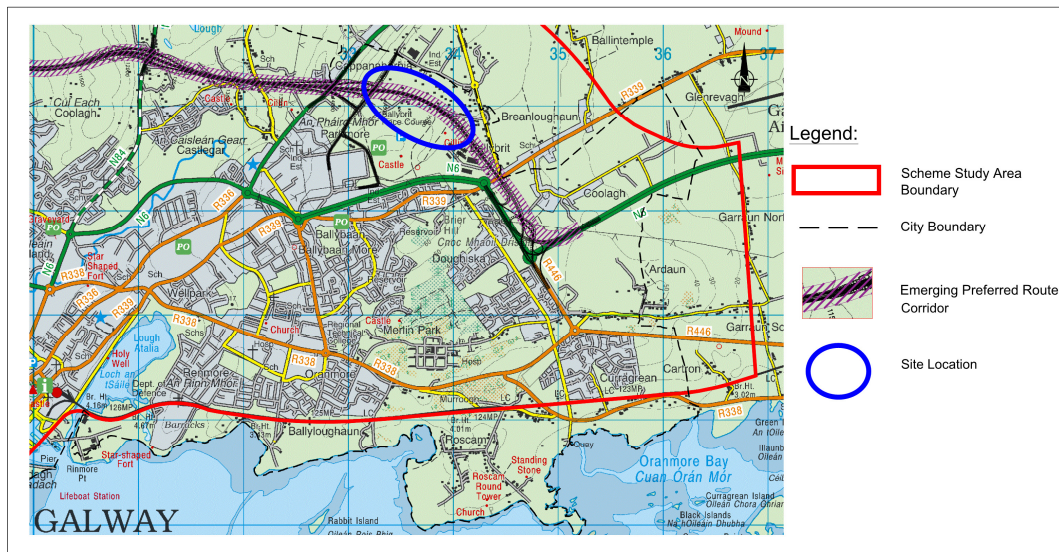

2.2 Function of the structure and obstacles crossed

The purpose of the Galway Racecourse Tunnel is as follows:

- Mitigate adverse impacts, namely disruption to operations and functioning on the Galway Racecourse

The proposed mainline passes through the north eastern corner of Galway Racecourse property and necessitates a cut and cover tunnel at circa Ch 14+950m, resulting in a tunnel length of approximately 240m.

Within the racecourse landholding the area to the west is not currently highly developed. However, this land is used on race days as car parking, as approximately 150,000 patrons visit the summer festival alone. The open cut is located to the north of the existing racecourse facilities e.g. Grand Stands, Tote Building and entrance buildings. At the eastern side of the landholding, the proposed tunnel is located below the existing stables and horsebox car park.

2.3 Choice of location

An extensive constraints and route selection study was carried out for the proposed road development and its findings are presented in the Route Selection Report (GCOB-4.04-009). As noted the EPRC was identified through a systematic assessment of the various route options with respect to the different constraints. The EPRC was identified as crossing through the Galway Racecourse lands at Ballybrit.

2.4 Site description and topography

The proposed cross-section of the carriageway through the tunnel is modified from the Type 1 Dual Carriageway cross-section as prescribed by TII DN-GEO-03036 Cross-sections and Headroom (formerly NRA TD 27) to be in accordance with TII DN-STR-03015 Design of Road Tunnels (formerly NRA BD78). The minimum geometry of the highway cross-section has been determined in consultation with TII. The main constraint on cross-section is maintaining the visibility envelope and facilitating vertical headroom and space proofing for overhead services. The tunnel is located on a slight horizontal bend and has a vertical high point located just to the west of it.

2.5 Vertical and horizontal alignments

The horizontal alignment through the tunnel consists of a 1020m curve throughout with superelevated crossfall of 3.5%. The vertical alignment (going from west to east) consists of a 14250m radius sag curve entering the tunnel followed by a -0.85% gradient connecting to a 6000m sag curve exiting the tunnel on the east with a low point east of the tunnel portal at Ch 15+223. The horizontal and vertical alignments are summarised in Table 2.1. For more information see drawing no. GCOB-SK-D-674 in Appendix A.

Table 2.1: Vertical and horizontal alignments

Name of Structure	N6 Mainline	
	Vertical Alignment	Horizontal Alignment
Racecourse Tunnel	Sag K Value = 142.5 Grade = -0.7% Sag K Value = 60	R = 1020m

2.6 Cross sectional dimensions

The tunnel cross-section contains two tubes, one for eastbound traffic and one westbound traffic separated by a central wall. The westbound tube requires a clear horizontal dimension of 13.0m and the eastbound tube requires a clear horizontal distance ranging from 11.95m – 13.45m.

This is to cater for the stopping sight distances of 215m for 100km/h design speed in accordance with NRA TII DN-GEO-03031 (formally NRA TD 9) as well as providing a minimum verge/walkways of 1200mm to comply with TII DN-STR-03015.

Within the tunnel, the highway alignment provides a separation distance of 1.5m between adjacent verges of the eastbound and westbound carriageways to facilitate the construction of a central wall.

Although TII DN-STR-03015 indicates a requirement for emergency stopping lanes, the document also notes that continuous emergency stopping lanes are generally not provided due to the associated high costs. A suitable alternative is to provide widened lane widths of 3.75m which has been adopted in this tunnel design in agreement with TII. This widened lane width, in addition to the hard strip and 1.2m verge, is anticipated to provide sufficient width to temporarily allow traffic pass a stranded vehicle.

The modified Type 1 Dual Carriageway cross-section proposed for Galway Racecourse Tunnel is:

Eastbound Carriageway

- Left hand verge/emergency walkway 1.2m
- Left hand Hard Strip 0.5m
- Carriageway Width 7.5m (2 x 3.75m lanes)
- Right hand Hard Strip 0.5m
- Right hand Verge/emergency walkway 1.2m
- Visibility Widening 1.05m – 2.55m

Westbound Carriageway

- Right hand verge/emergency walkway 1.2m
- Right hand Hard Strip 0.5m
- Carriageway Width 7.5m (2 x 3.75m lanes)
- Left Hand Hard Strip 0.5m
- Left hand Verge/emergency walkway 1.2m
- Visibility Widening 2.1m

Figure 2.2: Standard cross section and clearance requirements (Cut west to east)

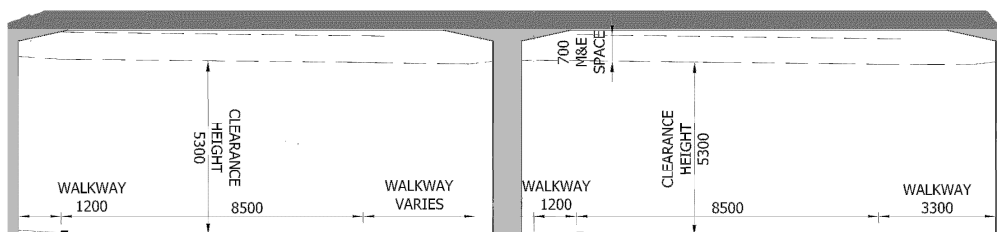

The tunnel carriageway maintains a constant cross-section along the length of the tunnel. The proposed operating headroom within the tunnel above the carriageways is 5.03m and an additional clearance of 0.25m is allowed for beneath the equipment gauge along the entire length of the tunnel giving a total clearance of 5.27m. This additional clearance allows for flapping tarpaulins and other protrusions from trucks.

For consistency with the clearance envelope provided at bridge structures, the minimum clearance of 5.3m will be provided at the carriageway and at the emergency walkways.

A height allowance of 0.7m is provided above the maximum clearance to accommodate the electrical equipment, ITS and tunnel signage. Any fireproof protection measures or construction tolerances, where applicable, will need to be provided outside the envelopes indicated in Figure 2.2 above.

2.7 Existing services

There are a number of services which traverse the proposed alignment of the tunnel. These include telecoms, underground electricity supply lines, public water mains and public surface and foul sewers. These services will have to be temporarily diverted during the construction of the tunnel and permanently reinstated following completion of the tunnel, noting that some will be reinstated off-line from their original location. Preliminary surveys have been undertaken to identify and locate services. These surveys are not exhaustive and on-site confirmation of these services are required during the subsequent design phases and during construction.

All the utility providers have been consulted during the preliminary design process. The existing services in the vicinity of the proposed structures are outlined in Table 2.2 below.

Table 2.2: Existing services

Name of Structure	Existing Services
Racecourse Tunnel	1 no. 375mm dia. foul sewer 1 no. 525mm dia. surface water sewer 1 no. 600mm dia. surface water sewer

The location of the surface and foul sewers close to the eastern portal is expected to remain at or close to the current location.

Due to the invert levels of this sewer, there will be an interface with the tunnel structure or portal. It is proposed to incorporate the utility diversions and crossings into the eastern tunnel portal. The foul sewer diversion will consist of diverting the existing 375mm sewer. The existing 525mm and 600mm diameter surface water sewers will be combined into a single 700mm diameter sewer.

2.8 Geotechnical summary

The general ground conditions consist of areas of soft to very stiff cohesive glacial till underlain by limestone. The rock is strong with medium to closely spaced discontinuities and non-intact zones.

The assessment of the geology, ground conditions and geotechnical aspects of the design and construction of the proposed road development at Galway Racecourse Tunnel is based on the following information:

- The fenceline.
- The vertical and horizontal alignment and
- The available ground investigation information.

The ground conditions along the proposed road development were determined using various sources of information including historic data, photographic evidence, observations from site walkovers, intrusive and non-intrusive site investigations, laboratory testing and on site investigation monitoring.

A conservative geotechnical design approach has been adopted for this assessment. In the event that supplementary information is made available the information will be assessed and the results of the assessment may lead to a more efficient design solution.

2.8.1 Ground investigations

Ground investigations were conducted at the tunnel location and in the immediate vicinity as part of the GCTP Phase II and III ground investigation. These ground investigations included both intrusive and non-intrusive investigations, which consisted of the following:

- Three rotary coreholes
- Two trial pits
- Two 2D resistivity profiles, and
- Nine seismic refraction profiles

Ground investigation in the immediate vicinity was also considered for establishing the ground conditions at the location of the tunnel. The plan location of the ground investigations is provided in Figure 2.3.

Figure 2.3: Plan location of ground investigations

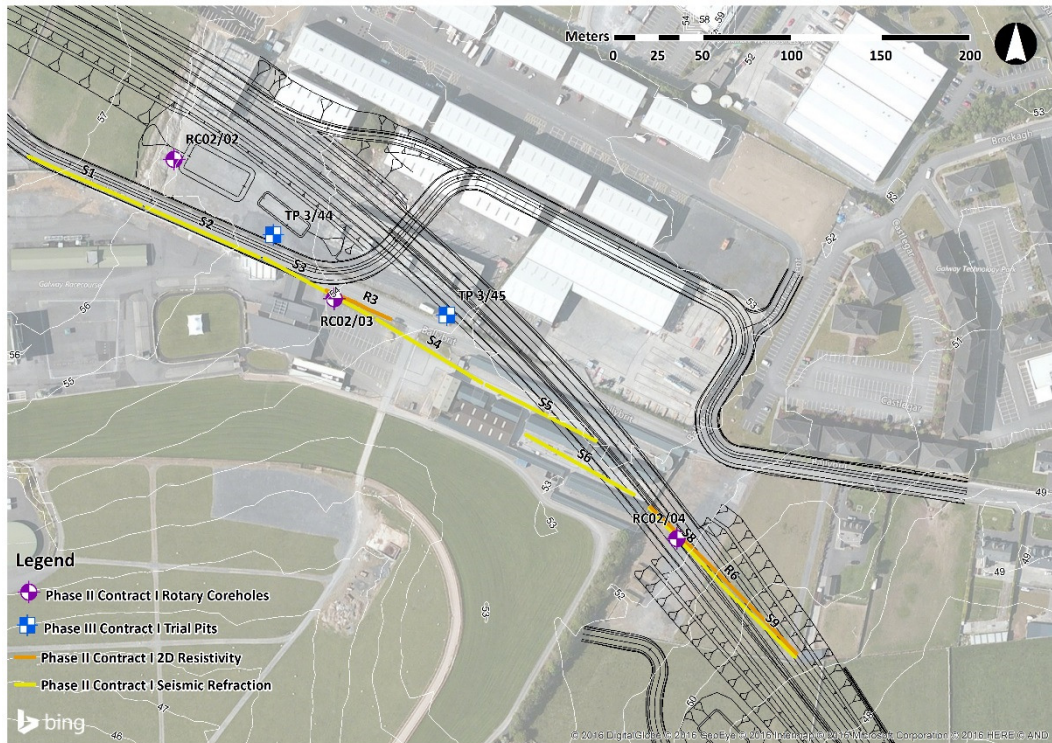

2.8.2 Ground conditions

The ground conditions are discussed in terms of:

- Topography
- Superficial deposits: Overburden details
- Solid Geology: Bedrock details

2.8.2.1 Topography

The topography at the tunnel footprint has elevations ranging from +51m to +54m mOD. The ground typically falls from west to east but is predominantly flat over the footprint of the tunnel.

2.8.2.2 Superficial deposits

Across the footprint of the tunnel, the overburden thickness, to the top of weathered rock, ranges from 3.3 to 6.6m below ground level. The overburden material is cohesive glacial till derived from limestone.

The exploratory logs classify the material as a soft to very stiff slightly sandy gravel silt/clay. An evaluation of the particle size distribution and atterberg limits indicate that the cohesive till is well graded and behaves as a clay.

Made ground was encountered for the top 1.0m, due to the urban development. Typically, soft to firm deposits were noted from 1.0 to 2.0m below ground level, followed by stiff to very stiff cohesive deposits. Trial pitting was terminated due to the very stiff material encountered. Both trial pits terminated at 2.5m (TP3/44) and 3.0m (TP3/45) below ground level. The seismic refraction survey corresponds with the intrusive survey and indicates that the overburden material becomes stiffer with depth.

2.8.2.3 Solid geology

The bedrock formation at the tunnel location is undifferentiated Visean Limestone of the Lower Carboniferous Age. The rockhead is indicated to be between 4.0m to 7.3m below ground level, but is typically approximately 5.0m below ground level across the tunnel footprint in accordance with the geophysical survey undertaken. Weathered zones, measuring 0.5 to 1.3m, were observed in all the exploratory holes. The rock is described as a strong to very strong, medium to thickly bedded, light to dark grey, fresh to moderately weathered with medium to closely spaced discontinuities and some slight solution weathering.

Non-intact zones, generally between 0.2 to 1.0m in thickness, were logged in all of the exploratory coreholes. These non-intact zones were encountered through the core log, with the apertures described as tight to moderately open with very firm clay infilling. Discontinuity logging indicates that dips are sub-horizontal, locally vertical.

Rock strength testing was assessed from the available coreholes. The rock is indicated to be medium strong and will require blasting to loosen in accordance with Franklin et al (1971). Los Angeles (LA) Abrasion testing in the Limestone yielded results of 27 to 28, which would be indicative of a hard rock. Slake durability testing was also conducted, with all test results reported greater than 95%.

Karst

The limestone is indicated to be susceptible to karstification. No surface features or geophysical anomalies were encountered at the tunnel location, however due to the existence of some calcite veining, non-intact zones, solution weathering and some geophysical anomalies in the wider region surrounding the tunnel, the karst activity is indicated to be high throughout the structure area.

2.9 Hydrogeology

The GSI classify the limestone bedrock at the tunnel location as being a regionally important karstified limestone aquifer (Rk), which is further characterised as having conduit flow (Rkc). The GSI have divided the limestone aquifer into a number of groundwater bodies (GWB) in the Galway region based on topography and groundwater level data. These GSI groundwater bodies have been refined during the ground investigation process as water level data was collected for the project. Based on the refined GWB the Galway Racecourse tunnel straddles the divide between groundwater draining south-eastwards in the Clarinbridge GWB and westwards in the Corrib-Clare GWB.

The record of groundwater levels for the project place the groundwater divide at approximately CH:15+000, which lies in between monitoring well RC-2-02 at the western tunnel portal and BH3/38 near the eastern portal. The data from these monitoring locations recorded peak groundwater levels in January 2016 with RC-2-02 measuring 45.0mOD and BH3/38 measuring 43.0mOD. Peak groundwater levels at CH: 15+000 are estimated to have been 45.2mOD. The range of groundwater levels recorded in RC-2-02 and BH3/38 are presented below in Table 2.3. Based on these minimum and maximum values groundwater levels are estimated for the west and east tunnel portals. The western portal is taken directly from RC-2-02 and the eastern portal is estimated based on water levels along the alignment.

Table 2.3: Groundwater monitoring data for the Galway Racecourse tunnel

Monitoring location	Approximate Chainage	Min recorded groundwater level mOD	Max recorded groundwater level mOD
RC-2-02	CH14+950:	41.8	45.0
BH3/38	CH15+500	40.3	43.0

Table 2.4: Estimated groundwater levels for the Galway Racecourse tunnel

Tunnel location	Road elevation mOD	Construction elevation mOD	Min estimated groundwater level mOD	Max estimated groundwater level mOD
CH:14+950 (Western Portal)	45.2	42.2	41.8	45.0
CH:15+180 (Eastern Portal)	43.4	40.4	41.0	44.0

Based on the data presented the winter groundwater level will rise within 1m of the proposed road levels. The road level at the western portal will lie 0.2m above the max recorded winter groundwater level, whilst the road level at the eastern portal lies 0.6m below the max estimated winter groundwater level. It is noted that the summer groundwater levels will lie greater than 2m below the road level.

Based on these groundwater levels the tunnel as well as the cutting (CH: 15+180 to CH15+980) at the eastern portal will require dewatering to ensure dry working conditions to the construction levels of the proposed road development.

The design of the tunnel and cutting will require waterproofing to prevent the ingress of water. The water proofing shall be to an elevation 2m greater than the maximum groundwater elevation presented in **Table 2.4**.

Based on the ground investigation data groundwater flow in the limestone bedrock is dominantly by fracture flow. Fracture flow pathways are likely to be encountered but the data from rock core recovery and geophysics indicates that solutional enlargement of these pathways will only be small scale, estimated to be of the order <10cm.

If karst features are encountered during the construction they will be examined by a hydrogeologist and remediated using a course drainage layer to ensure that they are not accidentally sealed during the construction process.

2.10 Archaeological summary

Galway Racecourse tunnel does not directly impact any known archaeological or cultural heritage sites. Archaeological and cultural heritage sites in the vicinity of the tunnel are listed in **Table 2.4** below.

Table 2.4: Relevant sites of archaeological and cultural heritage merit

Ref. No.	Townland	Description	Approx. Ch.	Dist. from proposed road development
AH 29 & BH 17	Ballybrit	Lisheen Graveyard Ringfort, souterrain, children's burial ground	15+200	100m south
AH 28	Ballybrit	Anomalous stone group (no visible trace survives)	14+900	150m south

2.11 Ecology summary

Galway Racecourse tunnel does not directly impact any known key ecological constraints. There is no habitat of significance in the area of the proposed tunnel as it comprises the existing built environment. The winter bird surveys detected sightings of various birds in the vicinity. The bat detectors also detected bat activity in the area. However, neither of these are significant constraints to the tunnel construction.

2.12 Environmental summary

The above sections summarise each of the likely environmental impacts. There are no known environmental constraints that are of such significance in this area as to impose a restriction on the construction of the proposed tunnel.

2.13 Sustainability

Concrete is the primary structural material for the tunnel. Concrete has a high durability performance and requires little maintenance during the design life

(120yrs), where the product is appropriately specified and executed. Portland cement replacements such as ground granulated blast-furnace slag (GGBS) will be used where appropriate.

The twin boxes are of integral construction. This form of construction minimises the inspection and maintenance requirements compared to non-integral forms of construction.

All structures can be demolished at the end of the service life of the tunnel, and much of the structural materials (concrete, steel etc.) can be recycled and reused.

The twin boxes are naturally ventilated using the piston effect of the vehicles as they drive through the tunnels. Thus the capital, running and maintenance costs of a mechanically ventilated system are obviated.

2.14 Tunnel Structure details

The tunnel structure consists of a pair of reinforced concrete boxes, one box for each direction. Two cross passages are provided, at approximately 80m from the tunnel portal. Further details are provided in Section 3.1.

2.15 Accommodation of M&E services in the tunnel

2.15.1 Ventilation and Mechanical services

The following aspects of the tunnel design are considered in this section, namely;

- Emergency Points
- Tunnel Ventilation (Natural)
- Fire Fighting Hydrant Main
- Portable First Aid Fire Extinguishers
- Mechanical Services to the Tunnel Services Building and Plant Rooms

2.15.2 Emergency Points

Emergency points shall be provided along the tunnel every 50m. These shall be include the equipment as outlined in BD 78 including firefighting facilities and communication systems.

2.15.3 Tunnel ventilation

The tunnel will be ventilated by natural means using the piston effect of vehicles to induce and push air through the tunnels in the direction of traffic. No mechanically aided systems shall be required. This means that no mechanical smoke control system is proposed which will require agreement with the Tunnel Design and Safety Consultation Group (TDSCG). This is considered typical for a tunnel of 240 m in length.

2.15.4 Tunnel fire main

Each tunnel will be provided with a fire main in ductile iron arranged such that they will be joined at each end of the tunnel to form a ring main.

As there is insufficient water supply available from the Local Authority to meet the needs of two hydrants operating simultaneously, a break tank(s) and fire pumps shall be provided and located adjacent to the tunnel service building. It is proposed that the water tank shall supply sufficient water to allow 25l/s for a minimum of one hour. This will require a minimum tank size of approximately 90m³ plus additional water required for the hose reel system.

Hydrants in accordance with local authority requirements shall be located at regular intervals not exceeding 100m. Within the tunnel, hydrant outlets shall be located approx.750mm above the walkway or verge.

The firefighting crew normally enter the non-fire tunnel where they will prepare and connect to the hydrant main in that tunnel before entering the fire tunnel via the tunnel cross passage doors.

The hydrants shall be used for wash down purposes in the tunnel on an as-needed basis.

2.15.5 Hose Reels

The fire main shall serve hose reel outlets located at 50m intervals. Each hose reel outlet shall be provided with a 30m hose of 19mm minimum internal diameter at 50m intervals to match the location on the emergency points.

2.15.6 First aid fire extinguishers

Two portable fire extinguishers for all types of fires shall be located at each emergency point location. Doors to fire extinguisher and fire hose reel enclosures shall be alarmed to give a signal to the emergency or tunnel control centre when opened.

2.15.7 Electrical services

The electrical services in the tunnel shall comprise of

- Complete Power Distribution System
- Standby Power System
- Tunnel Lighting
- Emergency Lighting
- Fire Detection
- Cable Containment and Support
- Electrical Infrastructure to Traffic Control, Communications and Information Systems

- Electrical Services to Tunnel Services Buildings and Plant Rooms

2.15.8 Power distribution

Power distribution in the tunnel will consist of low voltage (LV) distribution boards and cables. Life safety and firefighting services will be designed to operate under expected fire conditions and provided with backup power supplies in case of mains power failure. Backup protection will be provided by UPS and standby generator.

2.15.9 Lighting

Tunnel lighting will be designed to BS 5489: 2016 Part 2 Code of practice for the design of road lighting in tunnels. Lighting will be by suspended high level LED luminaires. Control of lighting in the tunnel will be via dimming and switching for safety and energy efficiency and will take account of night and day time conditions. A standby power supply will operate the tunnel lighting in the case of mains power failure. Standby power for the lighting system will be from the standby generator.

2.15.10 Emergency lighting

Emergency lighting will be provided by high level LED luminaires supported by a static inverter central battery system in the tunnel services building.

2.15.11 Fire detection

A fire detection system will be provided in the tunnel. This may include the following systems and devices:

- Linear heat detection system which includes sensor cables installed above the travel lanes that automatically activates an alarm at a designated temperature or rate of temperature rise.
- Visual smoke/flame detection system which detects smoke patterns and motion and flame colour and intensity by analysing images from cameras in the tunnel.
- Manual fire alarm points installed at periodic intervals in the tunnel which can be activated by personnel in the tunnel.

The exact system deployed will be based on the parameters of possible fires in the tunnel, environmental conditions in the tunnel and the detection strategy developed as part of detailed design.

2.15.12 Cable containment and support

A full cable containment and support system shall be installed in the tunnel including cable ladder, tray, trunking and conduit and suitable support bracketry. Generally, these will be installed at high level in the tunnel.

Electrical Infrastructure to Traffic Control, Communications and Information Systems. Electrical infrastructure (power, cables and cable containment, etc.) will be provided for the various Traffic Control, Communications and Information Systems as part of the electrical services.

These systems would include CCTV, VMS, EMS, Telephones, Traffic Monitoring, and Radio Broadcast Systems as required.

2.15.13 Distributed Antenna Systems (DAS)

A multi-operator in-tunnel system will be installed to improve mobile coverage. The proposed solution is a BTS or repeater driven distributed antenna system (DAS) designed to enhance three GSM operator's coverage.

The installed system can be broken down into the following distinct sections;

- MNO donor antenna
- MNO repeater
- Point of interface (POI – multi-operator combiner)
- Fibre optic master unit (OMU)
- Multiband remote unit (OMU)
- RF cabling and splitter system (x2)
- Tunnel coverage antennas (x4)

Where applicable, other radios bands are to be accommodated such as Tetra, FM and maintenance radio.

2.16 Location of the tunnel services, monitoring and maintenance building

The tunnel services, monitoring and maintenance building (TSB) shall be located on the north side of the western end of the tunnel. Refer to drawing GCOB-2700-D-1000 in Appendix A for details. The TSB may include office areas, control room, technical equipment room(s) (TER(s)), staff welfare facilities, stores and plant rooms to assist with the monitoring and control of traffic and systems both leading up to and within the tunnel.

The TSB will house operations personal and tunnel plant and equipment. Electrical services will be provided to the TSB including all power distribution, standby generators, lighting, life safety and communications requirements.

Heating, ventilation and air conditioning will be required to the TSB. In particular, the TER(s) containing all of the control and communicating equipment will be provided with duty and standby close control air conditioning systems.

Public health systems to the tunnel service building will include mains, cold and hot water supplies, and foul drainage to all sinks and sanitary ware.

Firefighting equipment to the service building will include portable first aid fire extinguishers. The TER(s) will be fitted with automatic gaseous fire suppression systems to protect the equipment within.

The duty and standby hydrant pumps (if required) for the tunnel hydrant system shall be located in the TSB. The water storage required shall be located externally immediately adjacent to the hydrant pump room.

It is generally anticipated that plant rooms shall be naturally ventilated.

Where temperatures within plant rooms cannot be contained within tenable conditions, wall mounted axial fans will be provided behind louvres to assist natural ventilation air flow rates. Electrical heaters shall be provided to ensure that all plant rooms are maintained above 4°C.

3 Structure and aesthetics

3.1 General description of recommended structure

At the typical cross-section, the construction of this tunnel consists of twin box construction with all elements constructed using cast insitu reinforced concrete, as indicated in Figure 3.1, or precast concrete box units, which are assembled longitudinally and transversely from discrete precast elements, as shown in Figure 3.2. Further details of the twin concrete boxes are provided in drawings GCOB-1700-D-S14-02-001, GCOB-1700-D-S14-02-002 and GCOB-1700-D-S14-02-003. For the span lengths at the typical cross-section, reinforced concrete is an efficient solution with low to medium ground cover, which is the case at this structure.

Figure 3.1: Insitu reinforced concrete box typical cross-section

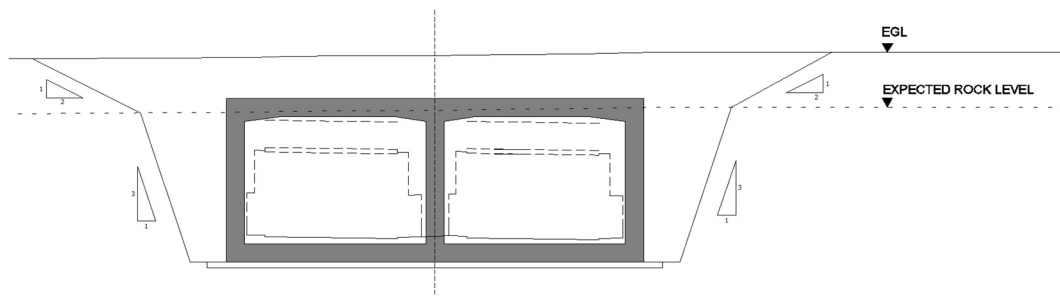
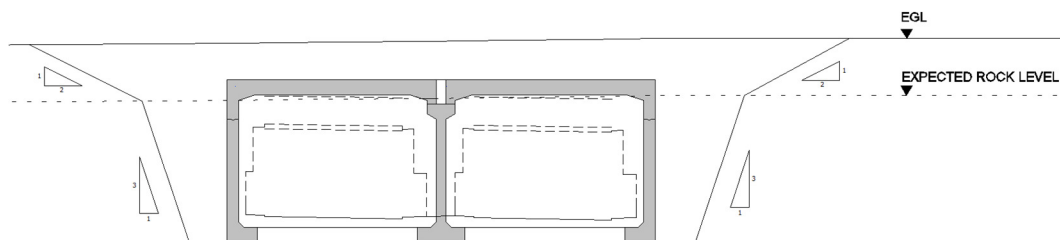

Figure 3.2: Precast concrete box typical cross-section



It is envisaged that the proposed future developments in the vicinity of the Racecourse Tunnel will be relatively low-lying, consisting of a few small single-storey buildings such as welfare facilities, parking areas and amenity spaces. This will be reflected in the legal agreement for the acquisition of the lands on a permanent basis beneath the surface, and the return of a way leave to Galway Racecourse for the use of the lands at the surface. Therefore, it is anticipated that future development will not significantly increase the loading on the tunnel over and above that already considered in the design.

3.2 Aesthetic considerations

The main visual impact on the overall landscape is the tunnel portals. The aesthetic treatment of the entrance and exit portals is important. Both portals are located below existing ground level minimising their visual impact. The depth of fill of 2m to 3m over the tunnel is relatively shallow. Therefore, the retaining structure above the tunnel portals as well as the wing walls are consistent in scale to the tunnel itself.

Smooth concrete finishes are to be provided at exposed faces inside the tunnel. Appropriate detailing, such as drip checks and coping elements will be used to improve the weathering performance of the structure.

3.3 Proposals for the recommended structure

The proposed Racecourse Tunnel consists of a 240m twin tube reinforced concrete cut and cover tunnel with central wall.

3.3.1 Proposed (structure) category

The proposed Racecourse Tunnel is a Category 3 structure in accordance with DN-STR-03001 (TII BD2/09).

3.3.2 Span arrangements

The westbound tube has a constant clear horizontal span of 13.0m while the eastbound tube has a horizontal span between 11.95m and 13.45m to accommodate the 215m stopping sight distance in the offside lane. These span arrangements cater for a minimum 1200mm nearside walkway/verge in each tube.

3.3.3 Approaches including run-on arrangements

The approach embankments will be constructed using a compacted acceptable material with Clause 6N material.

3.3.4 Substructure

The proposed substructure is a 240m buried twin tube reinforced concrete boxes and the substructure is integrated into the superstructure. Refer to section 3.3.6 for further details.

3.3.5 Foundation type

It is envisaged that the base of the proposed buried twin tube reinforced concrete boxes will be situated within rock. It is proposed that the tunnel will be founded on compacted acceptable Class 6N material placed on rock. In addition, compacted Class 6N1 material will be placed behind the tunnel walls and a permeable drainage layer will be provided at the back of structural elements above the water table.

3.3.6 Superstructure

The proposed superstructure is a 240m buried twin tube reinforced concrete boxes. Reinforced concrete headwalls and wing walls will be used at the tunnel portals.

3.3.7 Articulation arrangements, joints and bearings

It is anticipated that the 240m tunnel will contain movement joints and construction joints, at various locations along the length of the structure. There will be no bearings.

3.3.8 Waterproofing and Durability

A dense concrete mix will be provided with a low permeability. All insitu and precast concrete elements shall contain at least 50% GGBS. All exposed concrete shall be impregnated with hydrophobic pore liner in accordance with the TII Specification for Works.

The structural concrete of the tunnel will be designed to be watertight without the benefit of waterproofing systems.

Waterproofing provisions will be provided to the tunnel structure. Bridge deck waterproofing is required to the roof slab and the top of the base slab. All buried concrete less than 2m above the design high ground water level will be waterproofed with a proprietary tunnel waterproofing system. Two coats of epoxy resin waterproofing shall be applied on all other buried concrete surfaces not requiring a proprietary bridge deck/tunnel waterproofing.

Figure 3.3 and 3.4 below present typical details of tunnel waterproofing systems applicable to both insitu and precast options.

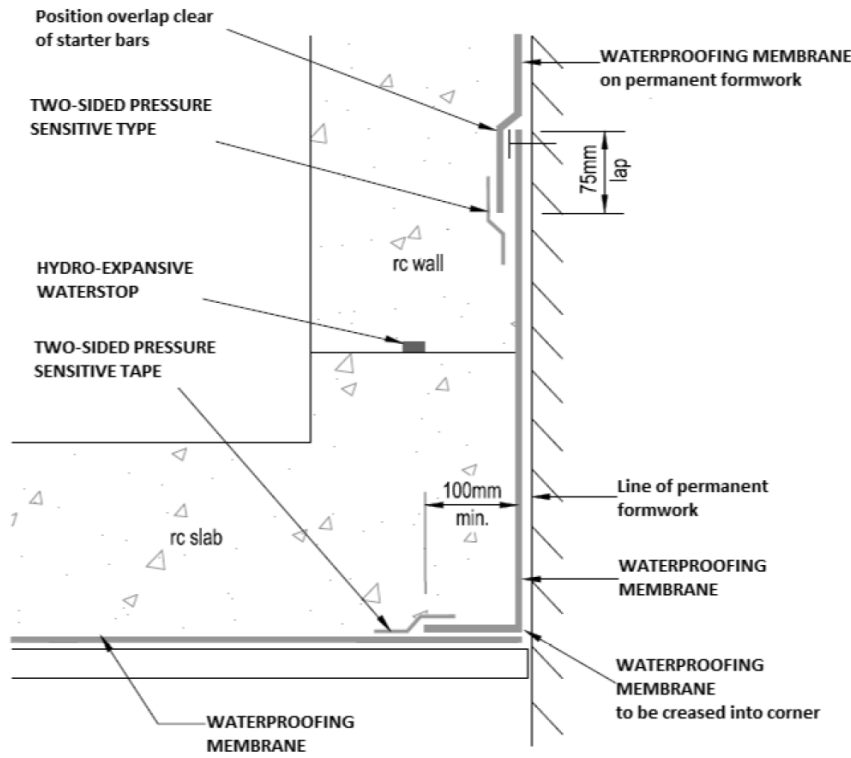
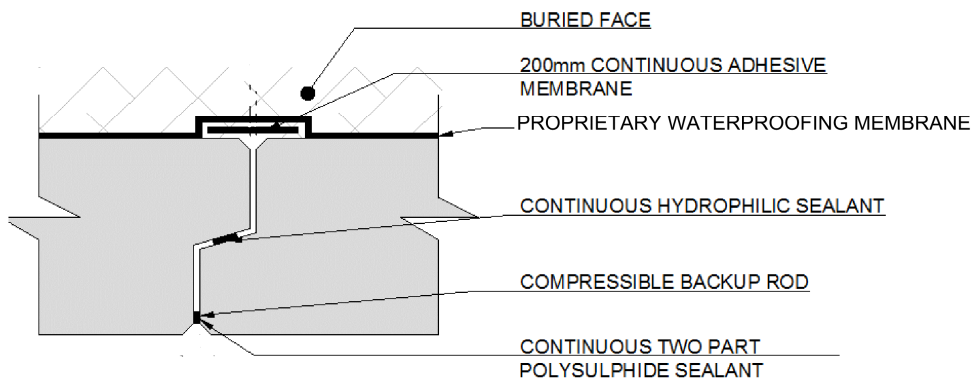
Figure 3.3: Insitu concrete tunnel waterproofing.**Figure 3.4: Precast concrete tunnel waterproofing.**

Two coats of epoxy resin waterproofing shall be applied on all other buried concrete surfaces not requiring a proprietary bridge deck / tunnel waterproofing. Where the tunnel is located below the design ground water level, the structure will be sealed using a proprietary below ground waterproofing system.

At movement joints within in-situ construction concrete, waterstops are provided, as indicated in Figure 3.5. In precast construction the detailing is given on Figure 3.4.

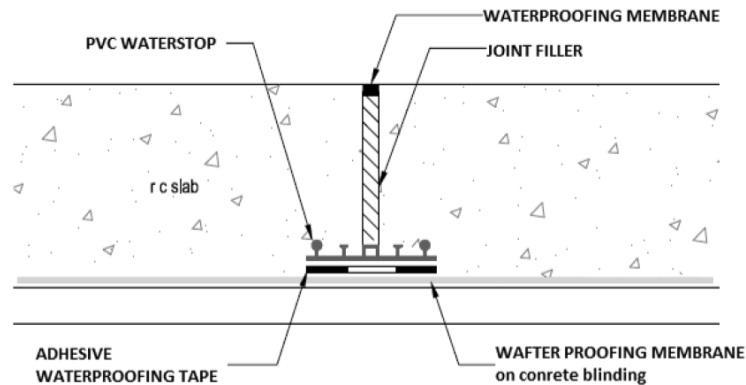
Figure 3.5: Insitu concrete slab movement joint.

3.3.9 Parapet

Refer to Section 4.3 for further details.

3.3.10 Inspection and maintenance

The headwalls and wing walls will be inspected from the mainline or from the access road above. The underside of the roof and the exposed portions of the walls can be inspected from beneath.

Waterproofing systems, joints, parapets etc. shall be designed for Working Life Category 2 (replaceable structural parts, up to 50 years design working life).

All other elements of the structure shall be designed for Working Life Category 5 (≥ 120 years design working life).

3.4 Description of tunnel traffic and road geometry

The following table indicates the predicted traffic volumes in the Racecourse Tunnel as extracted from the TII Central Growth AADT figures for opening year, 2024 and design year, 2039. Figures shown indicate medium and high growth scenarios.

Table 3.1: Galway Racecourse tunnel AADT and HGV%

Growth Scenarios	AADT	HGV
TII Medium Growth – 2024	32,700	4%
TII Medium Growth – 2039	38,700	5%
TII High Growth – 2024	32,950	4%
TII High Growth - 2039	39,800	4%

3.5 Accommodation of M&E services

Refer to section 2.15.

3.6 Emergency communication, escape facilities, fire points, cross passages

Refer to Section 2.15

3.7 Specific drainage details

A sealed drainage system will be provided within the cut and cover tunnel. Inflow and discharge rates will be calculated based on the influences of groundwater, rainfall, tunnel wall washing and firefighting purposes as outlined in TII DN-STR-03015 BD78/99.

There will be one drainage sump location, situated north of the carriageway and outside the eastern tunnel portal, as the vertical curvature falls along the tunnel alignment from west to east. The outfall from the sump will be pumped via a rising main to the private foul sewer serving the IDA Parkmore Industrial Park to connection which accounts for the proposed discharge rate and volume. See drawing no. GCOB-SK-D-809 in Appendix A for the proposed sump location.

3.7.1 Ground water seepage

Preliminary investigation of the groundwater table indicates that part of the tunnel lies below the regional water table. The tunnel will be designed to be fully sealed up to the extreme winter ground water level. The drainage system will be designed to cater for expected leakage rates for a sealed tunnel as per BD78/99.

3.7.2 Rainfall

The low point of the vertical alignment is located close to the eastern portal, therefore the approach to the tunnel is downhill toward both tunnel portals. Two separate carriageway drainage networks are provided to intercept the storm water and to prevent it from entering the tunnel, hence there is no external rainfall catchment contributing to the tunnel drainage system.

Drips from vehicle wheels are expected, but did not form part of the capacity assessment for the tunnel drainage network.

3.7.3 Tunnel wall washing

It is expected that tunnel wall washing will be carried out quarterly, therefore the volume and flow rates from same will be intermittent. All wash down from the tunnel will be collected in the drainage sump and pumped to the existing foul sewer. No water arising from wash down operations is permitted to discharge to the storm sewer or groundwater system. The quantity of water from wall washing are calculated as per BD78/99.

3.7.4 Firefighting and wash down following spillages

An allowance of two hydrants has been provided to be used by the Fire Services during firefighting incidents for a 1 hour duration. The duration of firefighting is to be confirmed with the Local Authority Fire Services. Flows and volumes for firefighting are calculated as per BD78/99. The firefighting flows will be contained in the firefighting/wash down buffer tank before being pumped to the foul sewer.

In the event of both a fire and the spillage of dangerous goods within the tunnel, the wash down will be contained within the firefighting/wash down buffer tank where it can be excavated manually as required.

3.7.5 Accidental spillage

A 25m³ impounding drainage sump, in accordance with HD33/15, will cater for a spillage of hazardous liquid from one road tanker. This will be located adjacent to the pump station and station. The impounding drainage sump can be isolated and evacuated manually to a bowser vehicle for appropriate disposal independently of the main pumps or discharge pipework. An oil and petrol interceptor will be provided prior to discharge to the main foul sewer in accordance with BD78/99.

3.7.6 Pump station

All pump station M&E will be designed in accordance with best practice guidelines, taking into consideration fire precautions. The figure below is an extract from BD78/99 showing a typical pumped drainage system arrangement within a tunnel environment.

Figure 3.6: Typical pumped drainage system

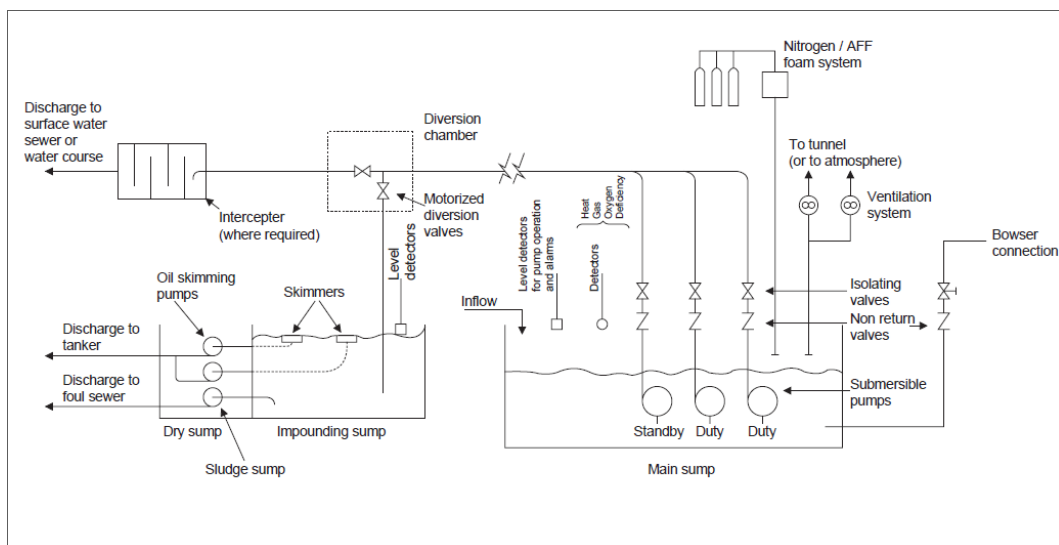

3.7.7 Fire main burst

In the event that a fire main is damaged and bursts, the excess water will be collected by the drainage system, transferred to the drainage sump where it will be

retained in the firefighting/wash down buffer tank, before being pumped the foul sewer. Due to the large quantity of water which could arise in such an incident the duty of the pumping system will include for the potential outflow from a broken pipe as per BD78/99 requirements.

3.8 Environmental conditions within the tunnel service, monitoring and maintenance building

Based on the following external design conditions the heating ventilation and air conditioning (HVAC) systems for the TSB shall be designed to achieve the following design internal conditions:

Table 3.2: Design internal conditions

	Summer	Winter
Design External Condition	26°C db, 19°C wb	-3°C db, -3°C wb
Design Internal Conditions		
Offices, reception	23+/-2°C wb	21+/-2°C wb
TER's	22+/-2°C wb	22+/-2°C wb
Plantrooms	<30 °C	>4 °C

3.9 Ventilation in the TSB

It is anticipated that the office and reception areas shall be naturally ventilated by means of openable windows.

The TER's will be provided with mechanical ventilation to slightly pressurise the room. The plantrooms shall be naturally ventilated by means of louvres located in walls or doors. A dedicated toilet extract system shall be provided to all washroom and changing facilities.

3.9.1 Justification

The design of HVAC systems shall be in accordance with CIBSE recommendations.

3.9.2 Pollution and vehicle emission

If deemed required based on estimated pollution levels in the vicinity of the tunnel, the supply air systems to the TSB facility shall be provided with charcoal filters to deal with emissions from vehicles.

3.9.3 Fresh air requirements

Fresh air requirements shall be in line with the recommendations for CIBSE. In general where mechanical ventilation is provided it shall be sized to deliver a minimum of 10l/s per person based on normal expected occupancy.

3.9.4 Monitoring and control

The HVAC systems shall be provided with a digital control system to allow users control temperature set points and plant running times within set limits. Frost protection will be provided to automatically start up HVAC to maintain minimum internal temperatures.

3.10 M&E elements of drainage in the TSB

Foul drainage from sinks and sanitary ware in the building shall be collected by means of a single pipe ventilated system. The foul drainage shall discharge by gravity to the private foul sewer in the vicinity of the proposed new building.

Storm water from roof and canopy areas shall be collected and shall discharge by gravity to the local authority main in the vicinity of the proposed new building.

3.10.1 Design criteria

Above ground foul drainage and storm water systems shall be in accordance with IS EN 12056. All design requirements from Irish Regulations Part H will be incorporated.

3.10.2 Volumes to be handled

The volumes of foul water from the proposed service building are domestic in nature. Normal occupancy levels are expected with an assumed usage of 60 litres per person per day.

The storm water system for the roof of building will be designed for a 1 in 100 year event.

3.10.3 Pumping equipment

It is anticipated that drainage from the service building shall be by gravity and no pumping equipment will be needed

3.11 Electrical services in the TSB

3.11.1 Electrical supply

It is expected that ESB Networks (ESBN) will provide an MV supply to the building. This will be rated at 10kV initially with a possible future increase to 20kV.

An ESBN MV substation will be required in the building.

3.11.2 Electrical distribution system

The electrical distribution system will be configured with two independent, diverse, active distribution paths (denoted A & B) serving equipment in the TSB and the tunnel. Both A & B systems will be fully live and operational at all times.

Distribution will be via distribution boards and cables.

3.11.3 MV switchgear

An incoming MV switchboard will be provided.

MV switchgear will be free-standing, air insulated, metal-clad type complying with EN 62271-200. MV breakers will be vacuum insulated and withdrawable.

3.11.4 Transformers

Two MV/LV step-down transformers will be provided. They will be dry type cast resin and will be low loss with an efficiency class of AoAk in accordance with EN 50541.

They will have dual 20kV and 10kV primary windings and 400V secondary winding.

Both will be rated to be capable of supporting the full load of the facility.

3.11.5 LV generator

A standby diesel generator will be provided. Output voltage will be 400V.

The generator will be rated to be capable of supporting the full load of the TSB and tunnel without load shedding.

Generator power rating category will be Prime Power i.e. capable of delivering continuous power while supplying a variable electrical load for an unlimited number of hours per year. It will comply with transient response performance class G2 as defined in ISO 8528-1-7.

The generator will have an integral base fuel tank with capacity to allow the generator to run for 12 hours on full load. A separate double skin bulk fuel tank will be installed in an external bunded area with capacity to allow the generator to run at full load for 48 hours. A fuel washing system will be installed.

A loadbank will be provided to allow the generator to be fully load tested regularly.

There will also be a facility to connect a generator to the switchgear via power lock connectors. This will allow a temporary mobile generator to be connected if the generator is out of operation for a period.

Generator operation will be controlled automatically from the Power Management System.

3.11.6 Uninterruptible Power Supply (UPS)

Two static UPSs and batteries will be provided to give A&B UPS supplies (2N redundancy).

UPS will be high efficiency with multiple operating modes (VFI, VI, VFD) including energy saving modes.

Both will be rated to be capable of supporting all essential services in the TER, control room and tunnel.

The UPSs will comply with I.S. EN 62040 'Uninterruptible Power Systems (UPS)'.

3.11.7 LV switchgear

Two main switchboards will be provided for the A and B supplies.

Automatic Power Factor Correction (PFC) equipment will be connected to the switchboards.

All Switchboards and Distribution Boards will comply with I.S. EN 61439 'Low Voltage Switchgear and Controlgear Assemblies'.

3.11.8 Power Management System (PMS)

A Power Management System will be provided to automatically control the switching between mains incomer, generator and UPSs.

The control system will be able to synchronise the generators to the electrical supply for testing and no-break return to mains.

3.11.9 Power monitoring system

Power meters will be installed on all supplies from the main switchboards and in individual sections of distribution boards.

A power monitoring package will monitor, record, analyse and present power data from the meters in spreadsheet and graphical form.

This will form part of the Building Management System (BMS).

3.11.10 Cable support & containment

A complete cable support and containment system will be installed using galvanised steel cable ladder, tray, basket, trunking, conduit and support steelwork.

ICT cabling distribution in the TER will be installed overhead (basket for copper and plastic trunking for fibre).

3.11.11 Small power distribution

Socket outlets will be provided as required for the operation and maintenance of the facility.

Dual redundant UPS supported A & B power supplies will be provided to racks in the TER via plug-in tap-offs on overhead A&B busways fed from dedicated Power Distribution Units (PDUs) in the TER.

Dual redundant UPS supported A & B power supplies will be provided to consoles in the control room.

3.11.12 Electric car charging

Electric car charging stations will not be provided.

Underground ducting will be installed from the LV Switchroom to the car park to allow for future installation of stations.

3.11.13 Interior lighting

LED luminaires will be used throughout. Generally, this will include downlights in circulation areas and toilets, recessed linear fittings in rooms and office spaces and surface mounted linear fittings in plantrooms.

Lux levels will generally be in accordance with CIBSE Code for Lighting 2012.

3.11.14 External lighting

External lighting will be provided by wall and column mounted LED fittings. All external luminaires will be vandal proof fittings.

Lux levels will generally be in accordance with CIBSE Code for Lighting 2012.

3.11.15 Lighting controls

A Lighting Control System (LCS) will be provided with a graphical front end on an LCS server.

Automatic (presence/absence detectors and light level sensors) and manual (switches) lighting control will be provided throughout.

External lighting will be controlled by external photocells and an on-off-auto switch in the distribution board.

3.11.16 Emergency lighting

Emergency lighting shall be provided by separate dedicated non-maintained LED luminaires supported by a 3 hour Central Battery System (CBS).

Maintained self-illuminated exit signs will be provided on escape routes with non-maintained emergency bulkheads over external doors.

The emergency lighting installation will comply fully with I.S. 3217 and the CBS with I.S. EN 50171 'Central Power Supply Systems'.

3.11.17 Fire Detection & Alarm System (FDAS)

An analogue, fully addressable, automatic Fire Detection & Alarm System will be provided in the building. It will be Category L1 to cover all areas.

A VESDA (very early warning aspirating smoke detection) system will be provided in the TER and its underfloor void.

The system will comply with I.S. 3218 'Fire Detection and Alarm Systems for Buildings - System Design, Installation, Servicing and Maintenance'. All components will comply with I.S. EN 54 'Fire Detection and Fire Alarm Systems'.

3.11.18 Fire suppression

A Fixed Gaseous Fire Extinguishing System will be provided in the TER.

The extinguishing agent shall work by using a heat absorption/chemical reaction process. It will be stored as a fluid and change to gas when released into the room. The storage cylinders will be stored in an adjacent separate room.

The system will comply with I.S. EN 15004 "Fixed firefighting systems - Gas extinguishing systems" and ISO 14520 "Gaseous fire-extinguishing systems".

3.11.19 Information & Communication Technology (ICT)

All ICT cabinets will be located in the TER.

All ICT outlets in the building will be wired to the racks in the TER using horizontal Cat 6A cabling.

A wireless network (WLAN) will be provided within the building.

3.11.20 Distributed Antenna System (DAS)

A full, multi-operator, repeater fed, active, fibre optic distribution system will be installed to allow mobile phone coverage in the tunnel.

A Point of Interface (POI) will be provided in a DAS room in the TSB to allow multiple GSM operators to connect their networks to the DAS which will combine and distribute the signals through antennas in the tunnel bores.

3.11.21 Intruder Detection & Alarm System (IDAS)

An Intruder Detection and Alarm System will be provided to prevent unauthorised access to the compound and building.

The system shall comply with I.S. EN 50131 'Alarm Systems – Intrusion Systems'.

3.11.22 CCTV

CCTV surveillance will be provided at the main gate, car park, building perimeter, entrances/exits, reception, lobbies and TER.

The CCTV system will be an IP PoE system generally comprising of internal and external cameras, colour display monitors, network recorder and associated equipment.

Images will be recorded on a local Network Video Recorder (NVR).

The system will comply with I.S. EN 50132 ‘Alarm Systems – CCTV Surveillance Systems for use in Security Applications’.

3.11.23 Access Control System (ACS)

Access control will be provided at access gates, entrances/exits, secure rooms and plantrooms to regulate access to secured areas of the facility.

Internally, proximity card readers will be used. External card readers will include a keypad for additional security (requires card and PIN for entry).

The system shall comply with I.S. EN 50133 ‘Alarm Systems – Access Control Systems for use in Security Applications’.

3.11.24 Earthing and bonding

A complete earthing and bonding system will be provided in full compliance with all requirements of the relevant standards and regulations.

The Main Earthing Terminal (MET) for the installation will be an earth bar in the LV Switchroom and the earthing and bonding system will be connected to that point.

A separate functional/clean earth will be provided. This will be connected directly to the MET only. A functional earth bar will be provided in the TER to connect all clean earths in the room.

3.11.25 Lighting Protection System (LPS)

A Lightning Protection System (LPS) will be provided on the building. The Lightning Protection Level (LPL) class will be based on a specific risk assessment carried out for the facility.

The LPS will be fully coordinated with the surge protection system.

The system will generally comprise roof level air termination network, dedicated down copper tape conductors, earth electrodes, test points and bonding of all extraneous metalwork.

The system and equipment shall comply with I.S. EN 62305 ‘Protection Against Lightning’ and I.S. EN 50164 ‘Lightning Protection Components (LPC)’.

3.11.26 Surge protection

Electrical and electronic systems within the building will be protected from any damage which may be caused by lightning electromagnetic impulse (LEMP) by designing, installing and testing a LEMP Protection Measures System (LPMS).

Service entry Surge Protection Devices (SPDs) and co-ordinated SPDs will form an integral part of the installation in keeping with the determined LPL protection level from the lightning protection system risk assessment.

All cables including incoming data links and comms lines entering the building will be surge protected with service entry SPDs.

The system and components shall comply with I.S. EN 62305-4 'Protection against lightning. Electrical and electronic systems within structures' and I.S. EN 61643 'Low Voltage Surge Protection Devices'.

3.12 Tunnel fire safety

3.12.1 Basis of design

It is noted that the EU Directive 2004/54/EC (transposed into Irish Law by SI 213 of 2006) does not apply to this tunnel as it is less than 500 m.

The UK guidance document BD 78/99 *Design of Road Tunnels* has been used as the main fire engineering guidance document with due cognisance of the risk based criteria outlined in the EU Directive. This guidance document is relevant to all tunnels > 150 m in length. The Galway Racecourse Tunnel is approximately 240 m in length. This document is therefore considered appropriate.

3.12.2 Fire risk

The Galway Racecourse tunnel is considered to be of relatively low risk for the following reasons:

- It is a relatively short tunnel and therefore:
 - The risk of a fire in the tunnel is lower.
 - Emergency services will be able to access the tunnel relatively easily.
 - Smoke will be able to escape from the tunnel relatively easily via the portals.
- Should a tunnel bore have to close due to planned maintenance, breakdown, etc. there is no need to put a contra-flow in operation as alternative traffic routes are available and could be used. This means that in all cases, traffic will be moving in the same direction.
- The Heavy Goods Vehicles (HGV) usage of the tunnels is relatively low (Galway Racecourse Tunnel is 4% and Lackagh Tunnel is 4%), the chance of a HGV fire within the tunnels is therefore low.

- Due to the geographical location of the tunnels in that there is little industry west of Galway City, it is not expected that a significant number of Dangerous Goods Vehicles (DGVs) will use the tunnels.
- The bore of each tunnel will be provided with a fire resisting separating wall. This will mean that means of escape provisions can be relatively easily achieved by the provision of escape doors within this wall.
- A traffic control system shall be put in place as described in section 4.7.3. The traffic control system shall provide management with the ability to detect potential congestion or queuing approaching the tunnel in order to take the necessary action. Barriers and signage shall be put in place to allow the closure of a lane, bore or tunnel as needed.
- Fire Fighting Water Storage Tanks have been designed to provide water from 2 no. hydrants at a flow rate of 33 l/s per hydrant for a duration of 1 hour. (This is from BD78/99 – Suggests to confirm that this is adequate with Local Fire Fighting Authority)
- A drainage system will be provided for accidental spillage of hazardous materials. A 25m³ impounding drainage sump, in accordance with HD33/15, will cater for a spillage of hazardous liquid from one road tanker. This will be located adjacent to the pump sump and station which are located at the low point of the alignment and outside of both tunnel structures. The impounding drainage sump can be isolated and evacuated manually to a bowser vehicle for appropriate disposal independently of the main pumps or discharge pipework.

For further information, refer to Section 4.6.

3.12.3 Means of escape

In the unlikely event that occupants do need to evacuate in the case of fire, they can do so via the portals or via cross-passage doors into the adjacent tunnel from where they can walk to one of the portals or await rescue.

Figure 3.7: Means of escape

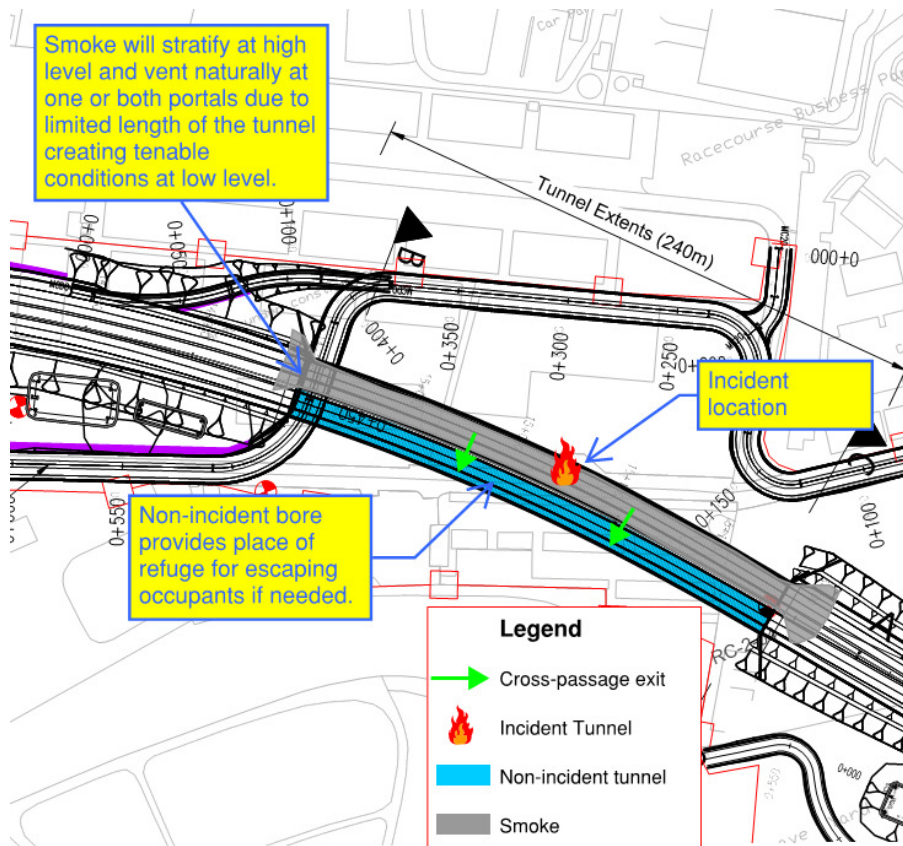

Owing to the fact that the bores are separated by a wall into which it is relatively easy to install doors, the separation distance between cross-passage doors can be relatively short which provides a significant safety benefit.

It is currently proposed to provide cross-passage doors within every 100 m in accordance with TII DN-STR-03015 BD78/99. Walkways will be provided on both sides of the tunnel to allow evacuating occupants to access the cross-passage escape doors. The evacuation scenario is illustrated in Figure 3.7.

3.12.4 Structural fire resistance

The structural resistance to fire is also a key aspect of any tunnel due to the high fire loads in such a confined environment. Design is required to rigorous fire curves (temperature vs. time). The Racecourse Tunnel structure shall be capable of resisting the Rijkswaterstaat (RWS) fire curve for a minimum of 120 minutes. Provisions, such as polypropylene fibre reinforcement or fire protection boards shall be put in place to reduce the risk of spalling - a phenomenon whereby portions of concrete fall off the tunnel lining during a fire therefore reducing the overall performance of the structure due to reduced concrete depth.

Particular attention needs to be given to the protection of any joints, and in particular sealing element within the joints.

3.12.5 Access and facilities for the fire service

In terms of getting to the tunnel and to the correct bore, the fire service will be able to approach the tunnel from either the east or the west. In addition, and to facilitate this solution, vehicle cross-overs will be provided outside, but close to, the tunnel portals. This will allow the fire service to cross onto the opposing traffic lanes should they need to as part of their operational response.

The fire service will be able to access the fire via the non-incident tunnel (if deemed necessary) which should be free from smoke. Short distances between cross-passage doors and the portals will aid fire-fighting operations as well as escape. Emergency points will be provided at regular 50 m intervals along each bore of the tunnel and hydrant main provided within each tunnel with hydrants no more than 100m apart. The fire service may use the main from either bore to fight the fire. The access scenario is illustrated in Figure 3.8 below.

Figure 3.8 : Fire service access

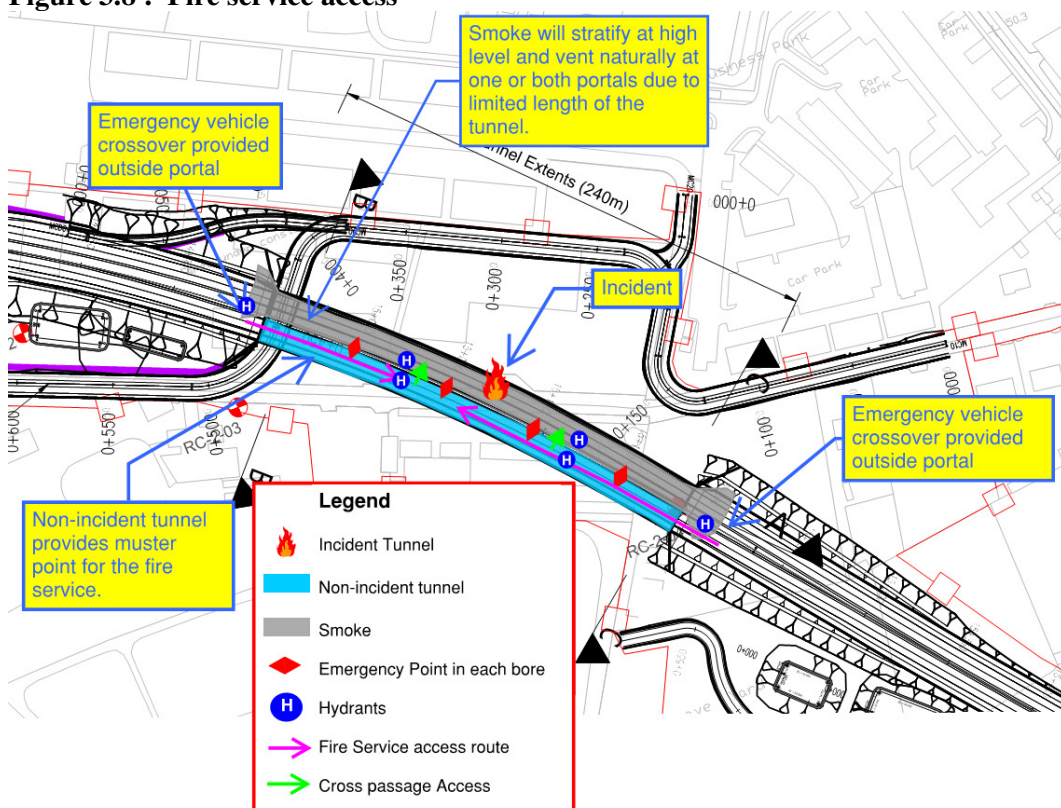

3.12.6 Systems

Other tunnel safety systems which will contribute to the management of the tunnel and therefore assist in maintaining adequate levels of safety are as follows:

- CCTV,
- Traffic control measures (see Section 4.7),
- Fire detection (linear heat or similar with manual call points),
- PA system,
- Emergency Lighting System (see 2.16.8 above),
- Signage.

The preliminary design of these systems are dealt within in other sections of this report.

3.13 Tunnel operation and plant control

Refer to sections 2.15, 2.16 and 3.12.

4 Safety

4.1 Traffic management during construction including land for temporary diversions

The main traffic access to Galway Racecourse is from Ballybrit Crescent at the north east of the track along Racecourse Avenue. Temporary accesses to Racecourse lands are established during race festivals from both the N17 on the west and the existing N6 to the south of the track. During the construction works there will be access and working restrictions during some of the racecourse events.

4.2 Safety during construction

Risks associated during the excavation stage are similar for each option. These will require careful consideration during planning of construction programme but are not considered here when comparing the tunnel construction options.

In situ construction requires significant amounts of formwork and temporary works during construction, which increases the risk of collapse and risk to site personnel.

For the installation of precast units/beams, there are a reduced number of operations which can be isolated and easier to identify the locations of workers as units are being put in place. The main risk associated with this will be the positioning of cranes and the large number of movements required for continuous installation of units.

From a health and safety during construction perspective there is no appreciable preference between the various options. All options can be built in a safe manner with the implementation of the appropriate health and safety measures.

4.3 Safety in use

Pedestrian protection will be provided at headwalls and wing walls in accordance with TII DN-STR-03011 (NRA BD 52). Safety barriers in accordance with TII DN-REQ-0303 (NRA TD 19) of at least N2 containment will be provided along the Racecourse Access Road in the vicinity of the western tunnel portal to protect vehicles on the access road falling onto the mainline. The safety barrier will be located within the verge.

4.4 Lighting

Lighting design shall be as described in Sections 2.16.7, 2.16.8, 3.12.13, 3.12.14, 3.12.15 and 3.12.16.

4.5 Protection of tunnel roof

A 75mm minimum protective concrete screed with 2.5% crossfall and 2.5% longitudinal fall will be provided over the tunnel roof waterproofing. Any vehicles necessary to undertake the waterproofing and screed operations must have inflatable rubber tyres to minimise any damage to the concrete and waterproofing. The initial layer of fill over the twin boxes shall be laid with care to avoid damaging the structure or waterproofing underneath. General construction traffic shall not be permitted on the tunnel roof until a sufficient depth of fill is placed above the twin box structure to adequately spread the load.

4.6 Compliance with EU road tunnel safety directive

4.6.1 EU directive 2004/54/EC

It is noted that the EU Directive 2004/54/EC (transposed into Irish Law by SI 213 of 2006) does not apply to this tunnel as it is less than 500 m.

TII DN-STR-03015 (BD78/99) outlines the requirements for the design of road tunnels. However, it should be noted that the criterion based approach outlined within this standard is now less favoured in Ireland than the risk based methodology put forward for consideration by EU Directive 2004/54/EC. It was therefore agreed with TII that the EU Directive would be used to determine design requirements for the Galway Racecourse Tunnel.

4.6.2 Tunnel categorisation

Tunnels are categorised from A to E using the “*European Agreement concerning the International Carriage of Dangerous Goods by Road (ADR)*”. This categorisation is based on the assumption that there are three major dangers in tunnels: (i) explosions, (ii) release of toxic gas or volatile toxic liquid and (iii) fires. The tunnel category, is assigned by the competent authority (Transport Infrastructure Ireland (TII) in Ireland) to a given road tunnel for the purpose of restricting the passage of transport units carrying dangerous goods. In Ireland, Dublin Port Tunnel (Category C) is the only tunnel with restrictions on the transit of dangerous goods³.

There is limited guidance available in Ireland regarding the carriage of dangerous goods in road tunnels. The most relevant precedent is that of the Dublin Port Tunnel. An examination of the Dublin Port Tunnel’s guidance on the carriage of dangerous goods identifies objectives which can be applied to the development of the proposed Galway Racecourse Tunnel.

³ Health and Safety Authority. (2012) Retrieved June 27, 2016 from the World Wide Web: [http://www.hsa.ie/eng/Publications and Forms/Publications/Chemical and Hazardous Substances/ADR Carriage of Dangerous Goods by Road A Guide for Business.pdf](http://www.hsa.ie/eng/Publications_and_Forms/Publications/Chemical_and_Hazardous_Substances/ADR_Carriage_of_Dangerous_Goods_by_Road_A_Guide_for_Business.pdf)

This guidance notes that no article or substance which would be reasonably likely to explode, dangerously react, produce a flame or dangerous evolution of heat or produce dangerous emissions of toxic, corrosive or flammable gases or vapours are permitted to utilise the tunnel.⁴ This guidance aligns with that of Tunnel Category C in accordance with the “*European Agreement concerning the International Carriage of Dangerous Goods by Road (ADR)*”.

The recommended tunnel category for the Racecourse and Lackagh Tunnels is C in accordance with the ADR. The considerations which contributed to this decision are as noted within Section 3.13.2 and as follows:

1. Tunnel Category C is recommended due to the expected low frequency of DGV’s and the availability of alternative routes.
2. Tunnel Category C is recommended as there would be a need and desire for HGVs to use the tunnel to access retail and service industries throughout the city and county and therefore must be accommodated.
3. An advanced intelligent transport system be implemented so as to control access to the entire network and in particular to the tunnels.

4.7 Communications and traffic control

4.7.1 General Description

Within this section of the Preliminary Design Report an outline of the Communications and Traffic Control systems proposed for inclusion within the tunnel are described. The preliminary design proposed incorporates the traffic control and communications systems both within the tunnel and on its immediate approach. This provides a holistic description of the traffic management and control systems required to facilitate tunnel operations.

4.7.2 Design criteria

The design methodology utilised for the preliminary design is based on the following documents:

- TII DMRB BD 78-99, ‘Design of Road Tunnels’.
- Directive 2004-54-EC Minimum Safety Requirements for Tunnels.

In addition to the above, where applicable, existing Irish tunnel design practices have been incorporated so as to promote general consistency and driver familiarity.

⁴ National Roads Authority. (2006) Bye Laws for the Dublin Port Tunnel. National Roads Authority.

Note that while BD 78-99 provides some guidance on what systems should be incorporated in a tunnel of this type, the extent and complexity of these systems are subject to the consultation and approval of the Tunnel Design and Safety Consultation Group (TDSCG).

At the time of development of this section of the Preliminary Design Report, the TDSCG had not been formed and hence this section has been developed in the absence of the TDSCG's input or approval.

4.7.3 Traffic management

To facilitate the traffic management of the tunnel, a number of systems are proposed which will enable a tunnel operator to monitor and control the tunnel operations of various operational scenarios.

These systems are essential in terms of:

- Closing a tunnel bore/lane in the event of an incident or to prevent incident, e.g. fire, queuing traffic, vehicle incident.
- Closing the tunnel bore/lane to facilitate maintenance.
- Reducing/varying the speed limit within the tunnel.
- Dealing with Over-Height Vehicles.

The systems proposed to facilitate the tunnel traffic management are as follows:

- Automatic Incident Detection
- CCTV
- Variable Speed Limits/Lane Control Signals
- Over-height Detection
- Barriers
- Traffic Signals
- Variable Message Signs
- Support Systems

Automatic Incident Detection

The tunnel shall include an Automatic Incident Detection (AID) system. The purpose of the AID is to allow the tunnel operator to monitor the live traffic status and be automatically alerted to traffic queuing, slow moving traffic and stopped vehicles. For the purpose of this preliminary design it is assumed that this requirement will be facilitated through the use of induction loops installed on the road surface at a frequency of every 50m on each lane throughout the tunnel, in addition to the exit/entrance of each lane/bore. On the immediate approach to the tunnel, AID will also be installed but at a frequency of every 500m.

Depending on the confidence in the technology and proven use within a tunnel environment, when carrying out the detailed design the induction loops may be replaced by radars or via the use of CCTV video analytics for the purpose of AID.

CCTV

The tunnel and tunnel approach shall be equipped with Closed Circuit Television (CCTV). The CCTV system is essential for tunnel operations, enabling the tunnel operator to visually monitor the tunnel status in real time and enabling informed decisions to be made. The CCTV systems will also allow the tunnel operator to verify any alarms that may be identified by the respective traffic control or SCADA/fire systems.

The CCTV cameras should be IP interfacing with a minimum resolution of P720 and have Pan, Tilt, Zoom (PTZ) functionality, allowing the tunnel operator to adjust viewing angles to cover all aspects of the tunnel. The CCTV system is envisaged to provide full coverage throughout the tunnel and approaches and as a minimum will be located as follows:

- CCTV cameras every 50m within the tunnel, including coverage of the tunnel SOS phones, laybys and any pedestrian crossover points that may be in place.

To facilitate remote monitoring of the following:

- Entrance to the tunnel bores
- Exit of the tunnel bores
- Over-height detection locations
- Over-height detection pull-in locations/barrier for Over-height vehicle escape
- Emergency Roadside Telephone (ERT) on approach to tunnel
- Any Variable Message Signage (VMS)/Lane Control Signals (LCS), traffic signals on approach to the tunnel.

Depending on the confidence in the technology and proven use within the tunnel environment, when carrying out the detailed design the CCTV may also support other tunnel system functions such as Automatic Incident Detection (AID) and automatic fire detection. This functionality may be enabled by sophisticated video analytic techniques that are now becoming available.

Lane Control Signals/Variable Speed Limits

The tunnel shall be equipped with Lane Control Signals (LCS) both within and on approach to the tunnel. The LCS provide the following functions:

- Enable Variable Speed Limits to be implemented.
 - This provides the operator with the facility to slow down traffic in the interest of safety or smoothing traffic flow.
- Enable individual lanes to be closed.
 - This provides the operator with the facility to close lanes within the tunnel in the event of an incident, or to facilitate maintenance.

The location of the LCS are envisaged to be located as follows:

- Above each lane at the entrance to the tunnel bore.
- Above each lane, every 50m throughout each tunnel bore.
- Above each lane on the tunnel approach (i.e. final 500m) at three locations.

On the tunnel approach, the LCS shall be located on portal gantries and accompanied by one MS4 type Variable Message Sign (VMS) to enable additional information to be disseminated to the driver.

In addition to the above, MS3 type VMS will be located approximately 1km in advance of the tunnel entrance. These VMS will provide advance warning of operational status of the tunnel lanes ahead, providing sufficient time for motorists to adjust their speed and driving approach.

Note, all LCS proposed for this project are single sided and are not designed to facilitate contra flow. If contra flow was to be incorporated in to the design, additional LCS would be required to cover the reverse direction in each bore. A revised alignment, VMS, barriers, signals etc. would also be required. The decision on whether to have a contra flow option should be a subject of discussion for the TDSCG.

Over-height Detection

Key to the operational success of the tunnel is to ensure that appropriate systems and procedures are in place to manage over-height vehicles. An over-height vehicle entering a tunnel poses a significant risk to the tunnel operations, infrastructure and general health/road safety.

To protect the tunnel against such risk, an 'Over-Height Vehicle Detection' system shall be utilised. The system has 3 main functions: the detection of the violating vehicle, provide effective communications to the driver to encourage diversion to an alternative route and safely closing the tunnel to prevent the over-height vehicle from entering.

On detection of an over-height vehicle, the violating vehicle driver will be prompted to take an alternative route via the use of VMS. Both the Over-Height Vehicle Detection system and VMS will be located at strategic locations in advance of the tunnel providing the driver with ample opportunity to take an alternative route. The system will also utilise Automatic Number Plate Recognition (ANPR) cameras to assist in providing a targeted message to the violating driver by making reference to the vehicles registration plate on the VMS display.

In the event that the over-height vehicle ignores all visual warnings provided by the VMS, the system will automatically initiate a safe tunnel shutdown procedure utilising the LCS, VMS, traffic signals and barriers at tunnel entrance to prevent the over-height vehicle from entering. The operator will be able to verify the existence of an over-height vehicle at the respective locations via the use of CCTV.

Advisory messages will be displayed to all drivers through the use of the schemes VMS both at the tunnel entrance and in advance, so as to keep all drivers informed of the tunnel status. In addition, the VMS in advance of the tunnel will also guide the over-height vehicle to a purpose built over-height exit point.

In the vicinity of the exit there will be an escape road with access controlled by a barrier as monitored and controlled by the tunnel operator. The escape road diverts the over-height vehicle to an alternative route (i.e. either an adjacent road, or sends the vehicle over the tunnel entrance and back in its direction of origin). Details of the diversion route to Racecourse Avenue in both the eastbound and westbound direction are shown on Figure 4.1 below.

Figure 4.1: Over-height vehicle escape roads

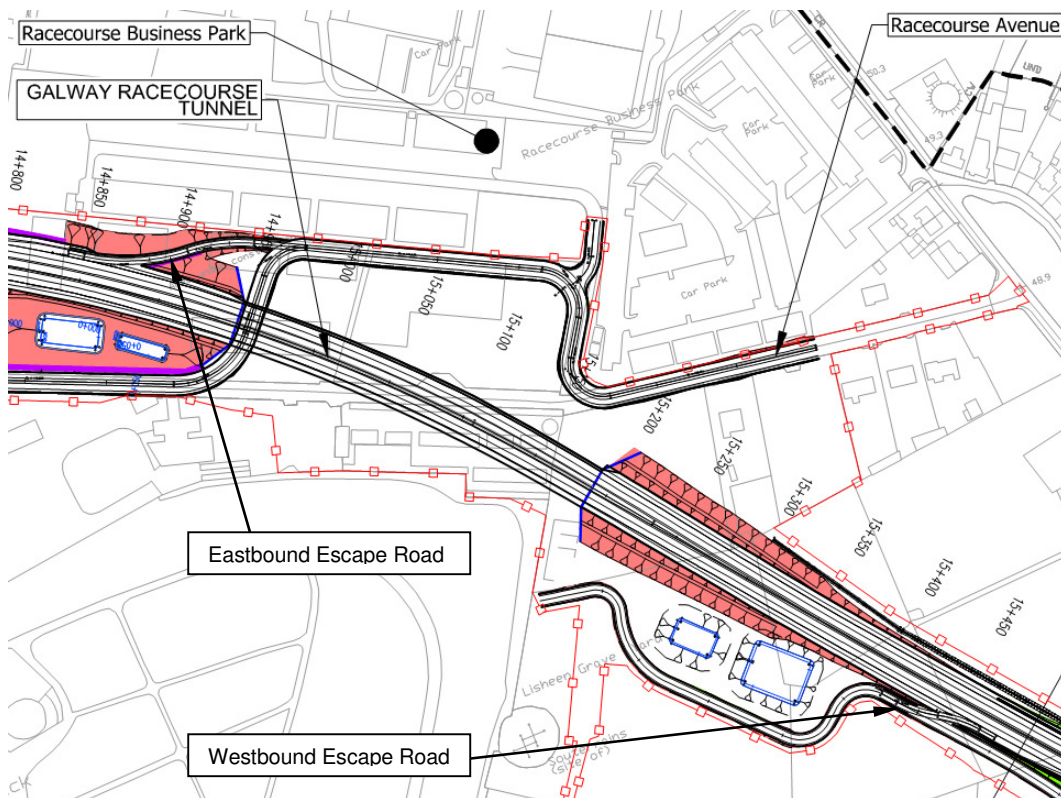

The operator shall be able to monitor the over-height vehicle and barrier via a CCTV camera and communicate with the driver via an Emergency Roadside Telephone strategically located in the vicinity of the escape barrier.

Once the over-height vehicle is dealt with, the operator can initiate the re-opening of the tunnel to continue normal operations.

Barriers

As referred to in the above sections, there are two barrier types proposed for the scheme, namely:

- Barrier at escape road(s) for to cater for Over-height Vehicles
- Barrier at each tunnel entrance.

Each of the above barriers will be remote controlled by the tunnel operator, with the tunnel barrier system being designed to automatically engage preprogrammed shutdown scenarios in the event of certain incidents (i.e. fire, queuing traffic, vehicle incident etc.) The tunnel operator will also have the facility to override and directly control the barriers as required and can verify their status via CCTV. The barriers will also have the facility to manually open/closed and be locked in place by maintenance/operational staff as required.

Traffic Signals

A three aspect traffic signals (Green, Amber, Red) will be provided either side of the carriageway at each tunnel entrance. The function of the traffic signal is to indicate the status of the tunnel bore with the red aspect indicating that the tunnel is closed and the green aspect indicating the tunnel is open. These messages will be reinforced by the status of the LCS, barriers and the display on the entrance VMS.

Variable Message Signs

As referred to in the above sections there are a number of VMS to be located on approach to the tunnel. The VMS are strategically located and provide the tunnel operator with an essential tools for dissemination of information to drivers.

The VMS envisaged to form part of this tunnel design are as follows:

- One VMS (MS4 type) at each tunnel entrance.
- One VMS (MS3 type) downstream of each Over-Height Vehicle Detection location.
- One VMS (MS4 type) on each LCS portal gantry (i.e. 3no. MS4 type VMS in advance of each tunnel entrance).
- One VMS (MS3 type) located at approximately 1km in advance of the tunnel entrance.

The VMS are envisaged to be controlled via the tunnel traffic control system and preprogrammed for various tunnel operational scenarios. Alternatively, the tunnel operator can apply free text to the VMS to suit the particular status of the tunnel.

All VMS will be remotely monitored by the tunnel operator, with CCTV being strategically located to ensure that VMS messages displayed can be visually verified.

In addition to the above the tunnel operator is also envisaged to have the facility to utilise other strategically located VMS across the road network to facilitate a more holistic approach to traffic management on the TII road network.

System Support Infrastructure

To facilitate the traffic control systems described in this section it is envisaged that an optical fibre network shall be installed throughout each tunnel bore and on the approaches. The purpose of the optical fibre network will be to provide secure and resilient connectivity between each of the tunnel systems roadside infrastructure and the main tunnel control systems.

The Information and Communication Technology (ICT) infrastructure to support the tunnel systems (i.e. servers, leased lines, equipment racks, switches, UPS) are envisaged to be housed with the tunnel services building located in the vicinity of the tunnel.

4.7.4 Telephone system

The tunnel bores will be equipped with SOS phones installed throughout each tunnel bore and will enable drivers/users to initiate audio communications directly with the tunnel operator in the event of an accident/breakdown.

The SOS phones will be located at 50m intervals throughout the tunnel and at each tunnel entrance and exit. In addition, SOS phones will be installed at the escape road barrier location/over-height vehicle exit points, to facilitate communications/instructions to be provided from the tunnel operator to the over-height vehicle driver.

In addition to the SOS phones, the scheme and tunnel approach will be supplemented with the equivalent Emergency Road Telephones (ERT) located at intervals no greater than 2km and in line with the TII CC-SPW-01500.

4.7.5 Emergency procedures

The traffic control systems will provide the tunnel operator with the facility to monitor and control vehicular access to the tunnel via technologies such as the VMS, LCS, Traffic signals and the barriers described. These can be utilised by the tunnel operator to initiate various emergency tunnel operational procedures in the event of an emergency and incident (i.e. accident, pedestrian within tunnel, fire etc.).

4.7.6 Traffic signs

Fixed traffic signs shall be provided in advance of the final junction before the tunnel on both approaches to the tunnel. These advanced fixed signs shall inform road users of the following:

- The tunnel ahead.
- The tunnel height.
- Restrictions on traffic permitted through the tunnel.
- Alternative route(s) for over-height vehicles and vehicles not permitted through the tunnel.

Fixed traffic signs shall be provided between the final junction and the tunnel portals on both approaches to the tunnel. The advanced signage shall inform road users:

- The tunnel ahead.
- The tunnel height.
- The tunnel length.

- Restrictions on traffic through the tunnel.
- An advanced direction sign indicating an emergency escape route for over-height vehicles ahead.
- A direction sign indicating the location of the emergency escape route for over-height vehicles.

4.7.7 Traffic monitoring

As part of the tunnel design it is envisaged that the monitoring and control of the tunnel operations shall be carried out remotely by a tunnel operator. The tunnel operator will have full access to the tunnel systems and CCTV both in the tunnel and on its approaches. This will enable the operator to make informed decisions throughout a variety of tunnel operational scenarios. It is envisaged that the tunnel operator will be located at the Dublin Tunnel Control Building and will have full access to the tunnel systems.

5 Cost

5.1 Budget estimate in current year, including whole life

The cost estimate for the Racecourse Tunnel has been prepared using typical cost per square metre rates for the envisaged tunnel configuration, tunnel cross-section, materials, construction methodology and maintenance requirements. These costs do not include general work items, such as preliminaries, site clearance, fencing, road markings and signs, road pavement, as these costs are considered as part of the overall scheme costs.

Table 5.1: Basis of cost estimate

Construction Options Considered	Estimated Rate (€/m ²)	
	Lower	Upper
Twin concrete box	3,410	4,351

The cost of the tunnel is highly dependent on the construction methodology and the temporary works necessary to build the tunnel, in addition to the form of construction.

Table 5.2: Estimated construction cost

Description	Cost [Million Euros] (Excl. VAT)
Racecourse Tunnel	22.1M to 28.2M

The operation and maintenance cost of €1 million per annum has been assumed in this cost estimate. The operations and maintenance cost for the Racecourse Tunnel calculated over a 60 year period with an average discount rate of 5% is €19.12 million.

The whole life cost of the Racecourse Tunnel based on the median capital cost and discounted operations and maintenance cost above is €43.75 million.

6 Design assessment criteria

6.1 Normal loading

Permanent Actions in accordance with IS EN 1991-1-1:2002 and the associated National Annex.

The structure will be designed for Load Models LM1 and LM2 in accordance with IS EN 1991-2:2003 and the associated National Annex.

6.2 Abnormal loading

Load Model 3 up to and including SV196 (where applicable) will be considered in accordance with IS EN 1991-2:2003 and the associated National Annex.

6.3 Footway live loading

Where applicable, a footway loading shall be in accordance with Clause 5.3.2.1 of IS EN 1991-2:2003. A nominal $q_{fk} = 5\text{kN/m}^2$ will be adopted.

6.4 Provision for exceptional abnormal loads

Not applicable.

6.5 Any special loading not covered above

No exceptional abnormal loads are proposed.

6.6 Heavy or high load route requirements and arrangements being made to preserve route

Not applicable.

6.7 Minimum headroom provided

The minimum headroom clearance for tunnel structure will be 5.3m.

6.8 Authorities consulted and any special conditions required

Consultation with relevant authorities is on-going. The following groups have been contacted as part of the scheme:

- Transport Infrastructure Ireland (TII)
- Galway County Council (GcoC)
- Galway City Council (GciC)

- Galway Fire Services
- Land and home owners

7 Ground conditions

The general ground conditions consist of areas of soft to very stiff cohesive glacial till underlain by limestone. The rock is strong with medium to closely spaced discontinuities and non-intact zones. Refer to **Section 2.8** for further information.

7.1 Geotechnical compatibility with proposed foundation design

The foundation types proposed for the River Galway Racecourse Tunnel are presented in **Section 3.3.5**.

The general ground conditions consist of areas of soft to very stiff cohesive glacial till underlain by limestone. The rock is strong with medium to closely spaced discontinuities and non-intact zones. Refer to **Section 2.8** for further information.

The construction of the tunnel will require surface excavation of up to 11.3m below ground level. The overburden material is anticipated to be very stiff from 3.0m below ground level, while rock is anticipated from 5.0m below ground level. Its estimated that approximately 25,000m³ of rock will be excavated. Rock strength testing and fracture index indicate that the rock will require blasting to loosen and extract.

Based on available ground investigation data, rock is anticipated to be above the alignment level for the entire footprint of the tunnel section, thus resulting in rock being the founding strata for the box units.

In the permanent condition there are no exposed soil or rock slopes as they are fully enclosed however in the temporary condition, soil and rock slopes are exposed in order to construct the tunnel. In accordance with the preliminary slope cutting assessment conducted in Chapter 5, Ground Conditions, Topography and Earthworks of the GCTP Preliminary Design Report, all permanent soil cuttings shall have a maximum gradient of 1 vertical to 2 horizontal. The acceptable temporary rock slopes will be evaluated based on supplementary ground investigation information at detailed design stage. Based on an assessment conducted in accordance with Chapter 5, Ground Conditions, Topography and Earthworks of the GCTP Preliminary Design Report, permanent rock cut slopes of 1V:1.5H and 1V:1H are achievable where intact rock with minor discontinuities are encountered.

The excavation process may expose karst features within the construction footprint. As features can extend both vertically and laterally into the surrounding region, any feature encountered shall be fully assessed and isolated prior and during the construction process.

A methodology for the evaluation and treatment of karst features shall be conducted in accordance with the Construction Environmental Management Plan (CEMP).

Material selected for backfilling and the compaction procedure required for the box units shall be conducted in accordance with guidelines provided in this document and the TII SRW Series 600 Earthworks.

Uncontaminated soil and stone materials which are not suitable for re-use will be disposed of to an appropriate site which is permitted under the Waste Management (Facility Permit and Registration) Regulations 2007 and (Amendment) Regulations 2008, 2014, 2015 to accept soil and stone.

7.2 Hydrogeological compatibility with proposed foundation design

The elevated groundwater table in the Briarhill area requires that the base and sides of the tunnel will require waterproofing to a minimum of 2m above the maximum recorded groundwater levels.

Dewatering will be required for the length of the tunnel and also the cutting at the eastern portal. The initial stages of the construction will require the construction of a carrier drain that links to an infiltration basin east of the Monivea Road so that groundwater intersected during construction of the road and runoff from the road during operation can be collected and discharged appropriately.

8 Drawings and documents

8.1 List of all documents accompanying the submission

Table 8.1: Submission documents

Document Reference	Document	Appendix
GCOB-1700-D-S14-02-001	Galway Racecourse Tunnel General Arrangement – Plan, Profile and Section	Appendix A
GCOB-1700-D-S14-02-002	Galway Racecourse Tunnel General Arrangement - Tunnel Portal	Appendix A
GCOB-1700-D-S14-02-0023	Galway Racecourse Tunnel General Arrangement – Utilities at South East Portal	Appendix A
GCOB-2700-D-1000	Galway Racecourse Tunnel Proposed Technical Services Building	Appendix A
GCOB-SK-D-674	Galway Racecourse Tunnel Plan and Profile Alignment	Appendix A
GCOB-SK-D-809	Galway Racecourse Tunnel – Proposed Sump and Sewer Location	Appendix A
	Geotechnical Factual Report	Appendix B

Appendix A

Drawings

- NOTES:**
- ALL DIMENSIONS ARE SHOWN IN MILLIMETRES UNLESS NOTED OTHERWISE.
 - ALL LEVELS ARE SHOWN IN METRES ABOVE ORDINANCE DATUM.

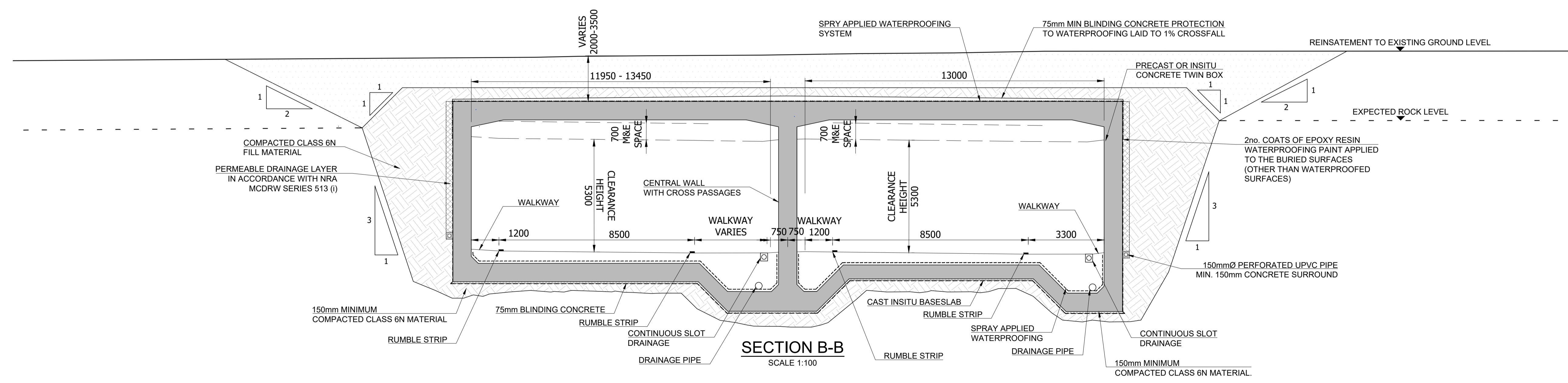
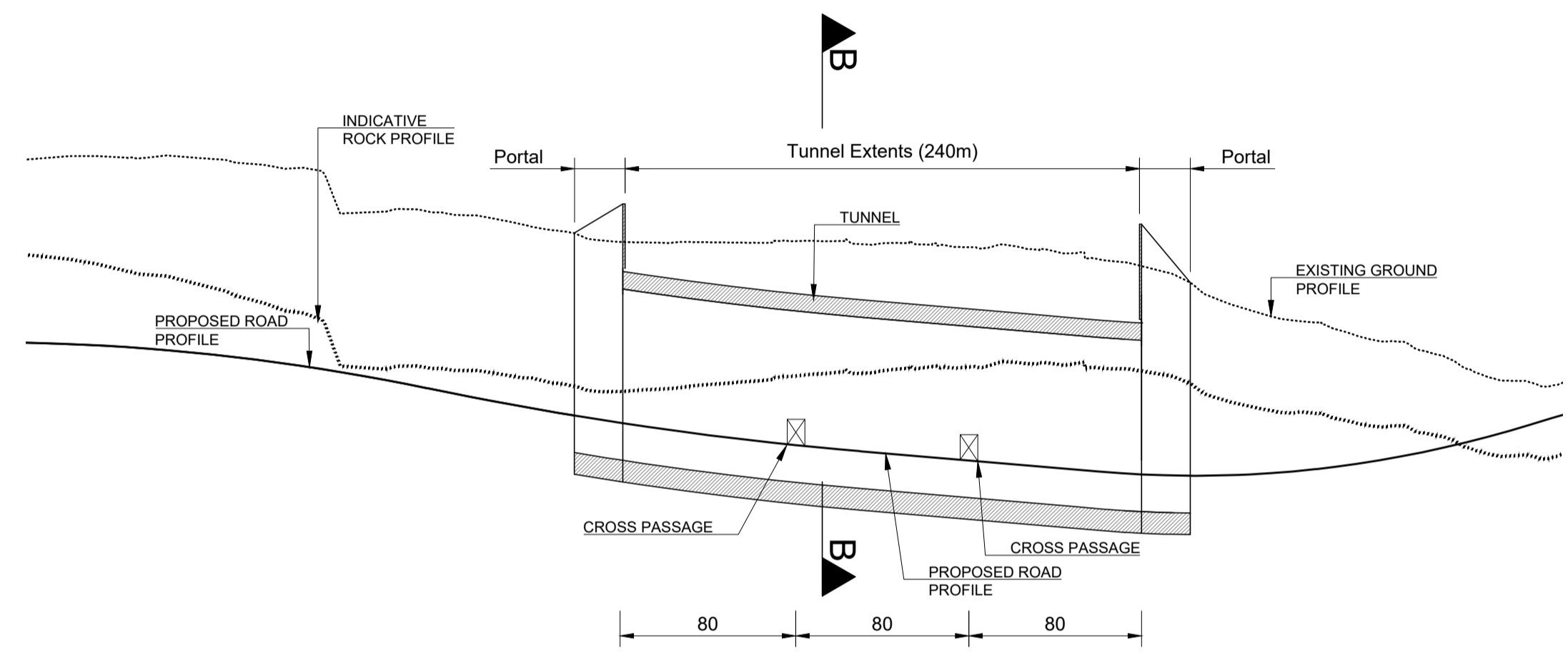
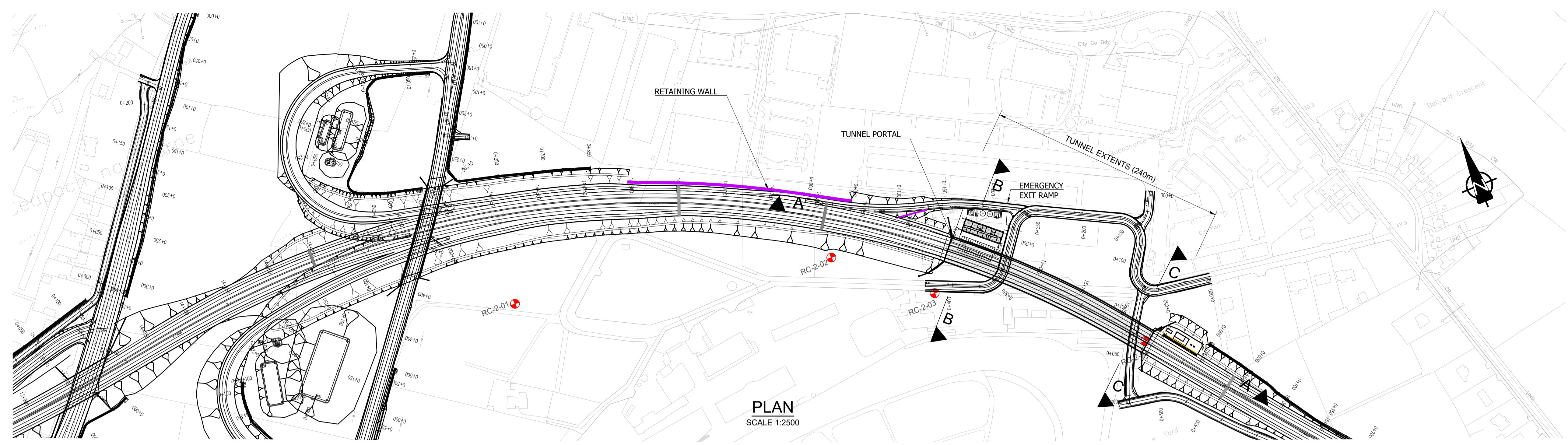

San áireamh tá sonraíocht Shuirbhíreacht Ordánais Éireann arna atáirgeadh faoi Cheadúnas OSI Uimh. 2010/17CCMA/Comhairle Contae na Gaillimhe. Sáraíonn atáirgeadh neamhdídarthaí cóipeacht Shuirbhíreacht Ordánais Éireann agus Rialtas na hÉireann. © Shuirbhíreacht Ordánais Éireann, 2010.

© Shuirbhíreacht Ordánais Éireann. Gach ceart ar chosaint.
Uimhir cheadúnais 2010/17CCMA/Comhairle Contae na Gaillimhe.

Includes Ordnance Survey Ireland data reproduced under OSI Licence number 2010/17CCMA/Galway County Council.
Unauthorised reproduction infringes Ordnance Survey Ireland and Government of Ireland copyright. © Ordnance Survey Ireland, 2010.

© Ordnance Survey Ireland. All rights reserved. Licence number 2010/17CCMA/Galway County Council.

Clients

Consultant

Corporate House
City East Business Park
Ballybriff, Galway, Ireland.

Tel +353 (0)91 460675
www.N6GalwayCity.ie
www.arup.ie

Job Title
N6 Galway City Ring Road

Scale
As Noted

Date
November 2016

Issue	Date	By	Chkd	Appd
I3	30/06/2017	LM	FB	PM
I2	02/06/2017	LM	FB	PM
I1	15/11/2016	AR	FB	PM

Drawing Title
S14-02 Galway Racecourse Tunnel Plan, Profile & Section

Drawing Status
For Information

Job No
233985

Drawing No
GCOB-1700-D-S14-02-001

Issue
I3

- NOTES:**
- ALL DIMENSIONS ARE SHOWN IN MILLIMETRES UNLESS NOTED OTHERWISE.
 - ALL LEVELS ARE SHOWN IN METRES ABOVE ORDINANCE DATUM.

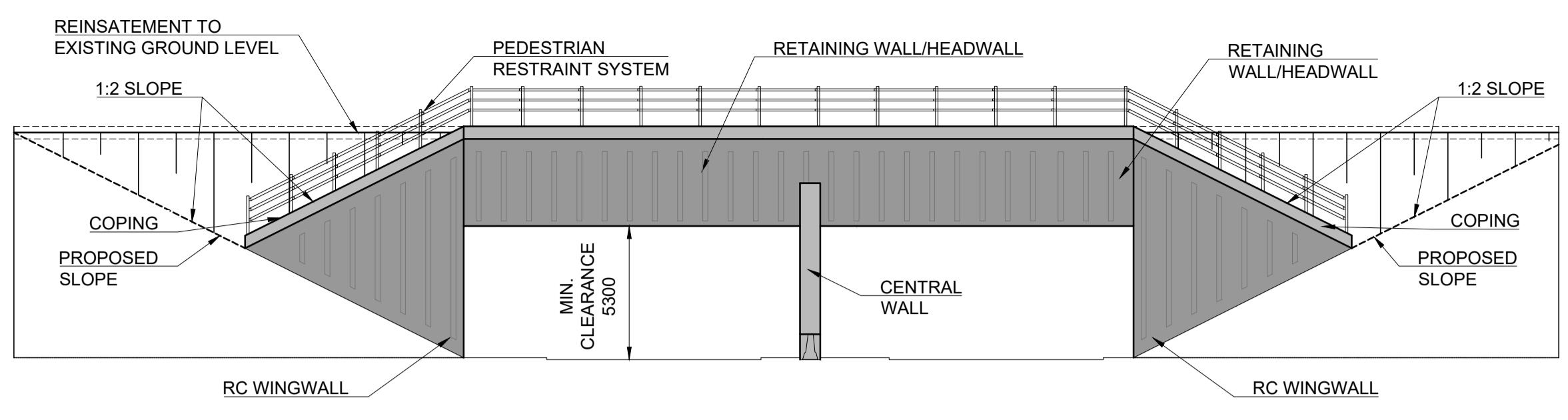

ELEVATION SE PORTAL
SCALE 1:200

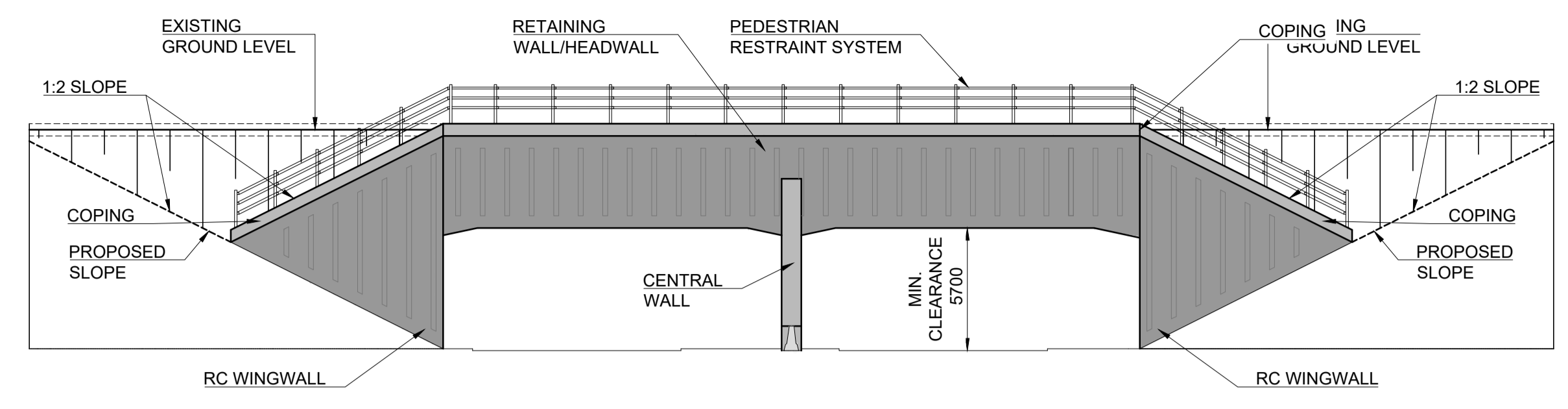

ELEVATION NW PORTAL
SCALE 1:200

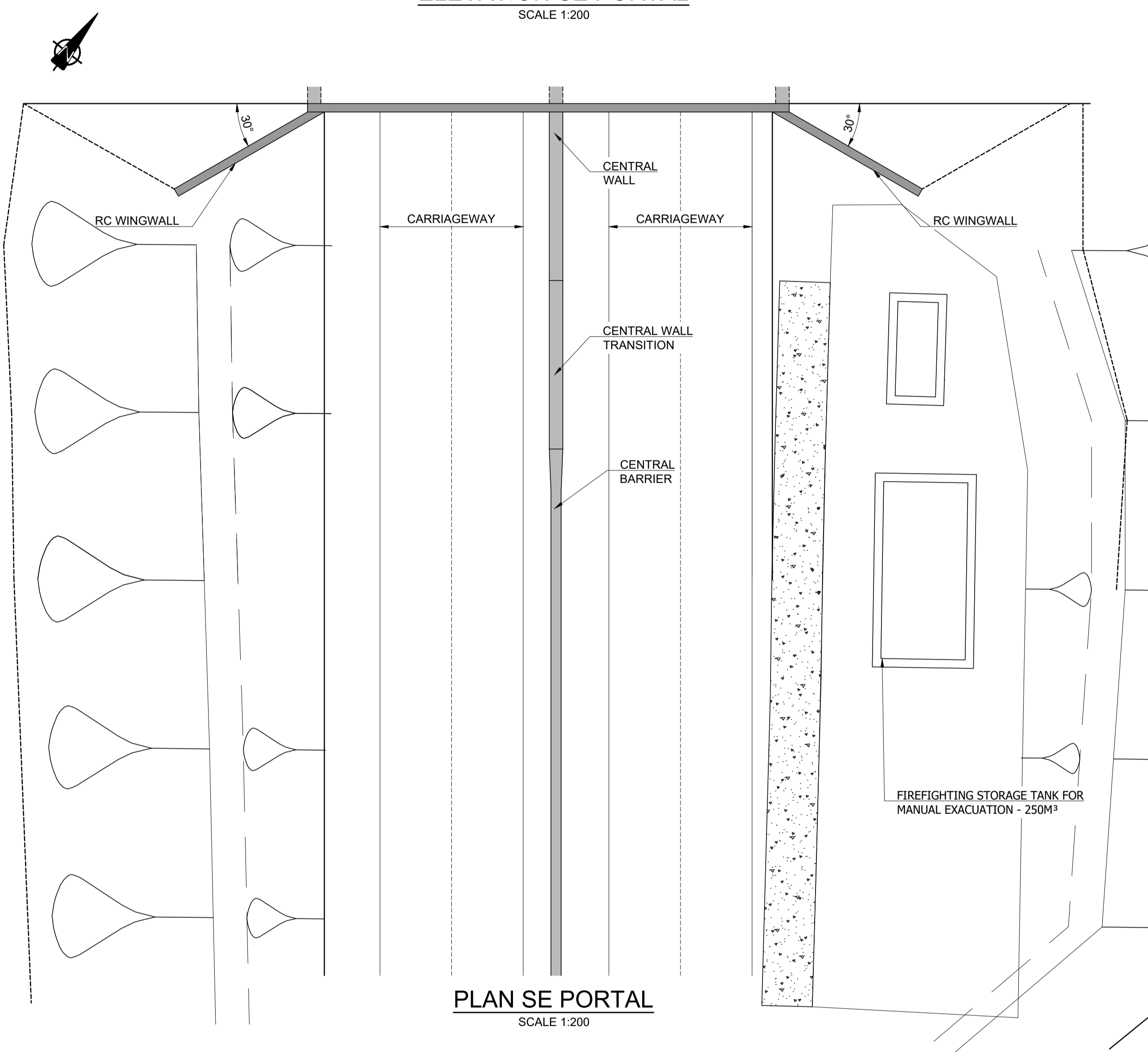

PLAN SE PORTAL
SCALE 1:200

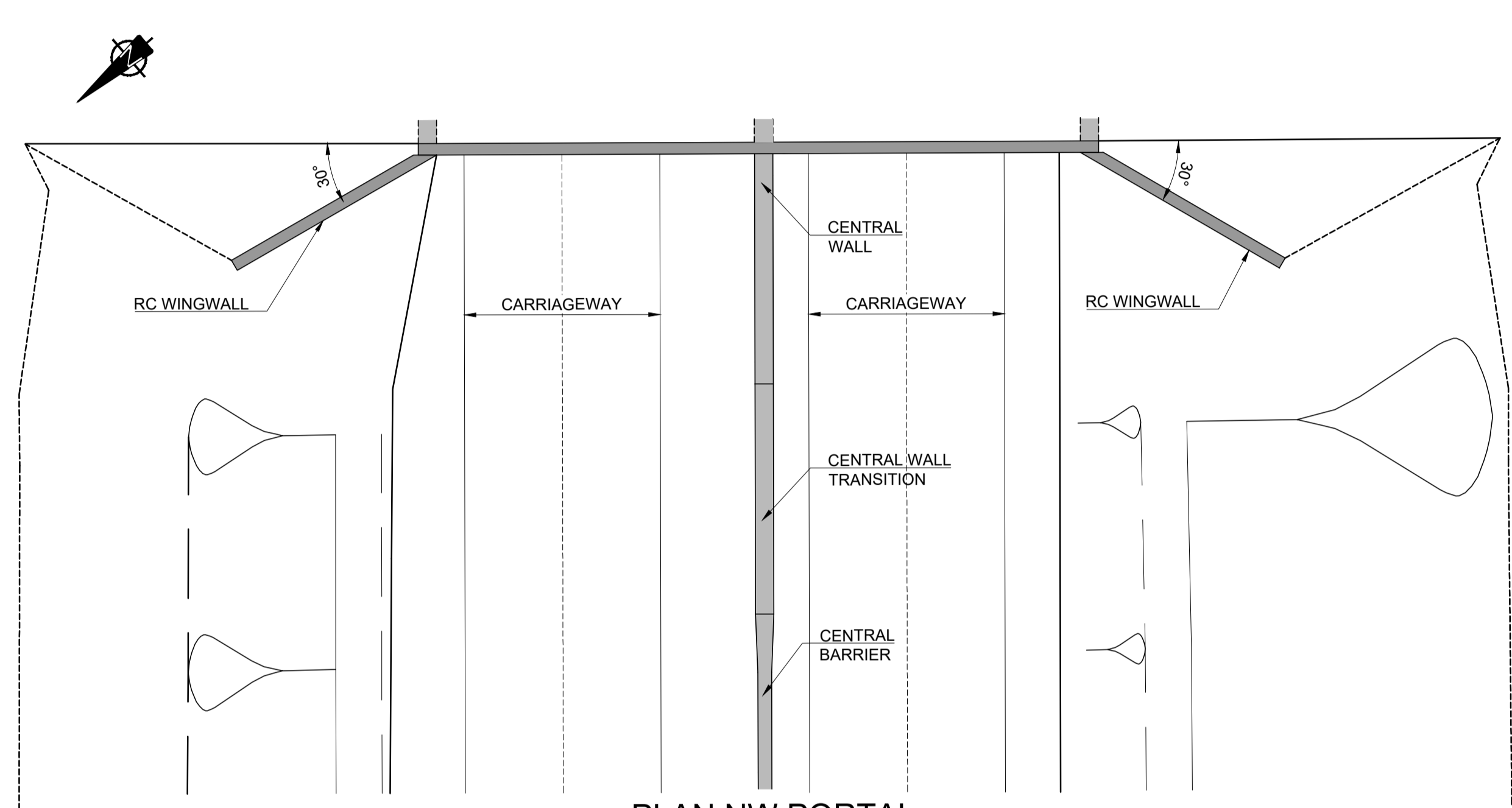

PLAN NW PORTAL
SCALE 1:200

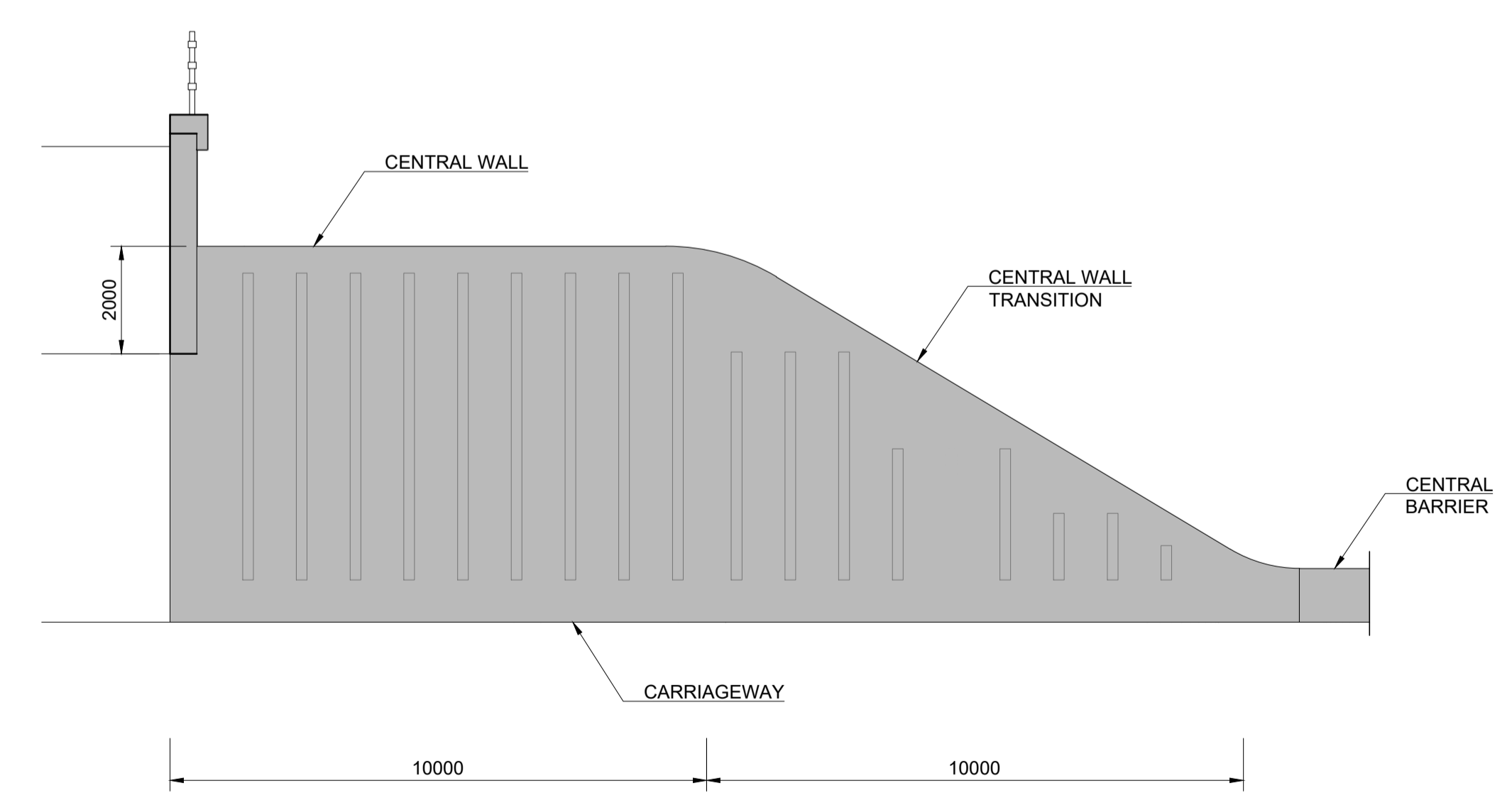

ELEVATION OF CENTRAL WALL
SCALE 1:100

San áireamh tá sonraíocht Shuirbhéireachtí Ordánais Éireann arna atáirgeadh faoi Cheadúnas OSI Uimh. 2010/17CCMA/Comhairle Contae na Gaillimhe. Sírúinn atáirgeadh neamhdáraithe cóipeacht Shuirbhéireachtí Ordánais Éireann agus Rialtas na hÉireann. © Suirbhéireachtí Ordánais Éireann, 2010.

© Suirbhéireacht Ordánais Éireann. Gach ceart ar chosaint. Uimhir cheadúnais 2010/17CCMA/Comhairle Contae na Gaillimhe.

Includes Ordnance Survey Ireland data reproduced under OSI Licence number 2010/17CCMA/Galway County Council. Unauthorised reproduction infringes Ordnance Survey Ireland and Government of Ireland copyright. © Ordnance Survey Ireland, 2010.

© Ordnance Survey Ireland. All rights reserved. Licence number 2010/17CCMA/Galway County Council.

Clients

Consultant

Corporate House
City East Business Park
Ballybrit, Galway, Ireland.

Tel +353 (0)91 460675
www.N6GalwayCity.ie
www.arup.ie

Job Title
N6 Galway City Ring Road

Scale
As Noted

Date
November 2016

I2	30/06/2017	LM	FB	PM
I1	02/06/2017	LM	FB	PM
Issue	Date	By	Chkd	Appd

Drawing Title
S14-02 Galway Racecourse Tunnel Tunnel Portal

Drawing Status

For Information

Job No	Drawing No	Issue
233985	GCOB-1700-D-S14-02-002	12

- NOTES:**
1. ALL DIMENSIONS ARE SHOWN IN MILLIMETRES UNLESS NOTED OTHERWISE.
 2. ALL LEVELS ARE SHOWN IN METRES ABOVE ORDINANCE DATUM.

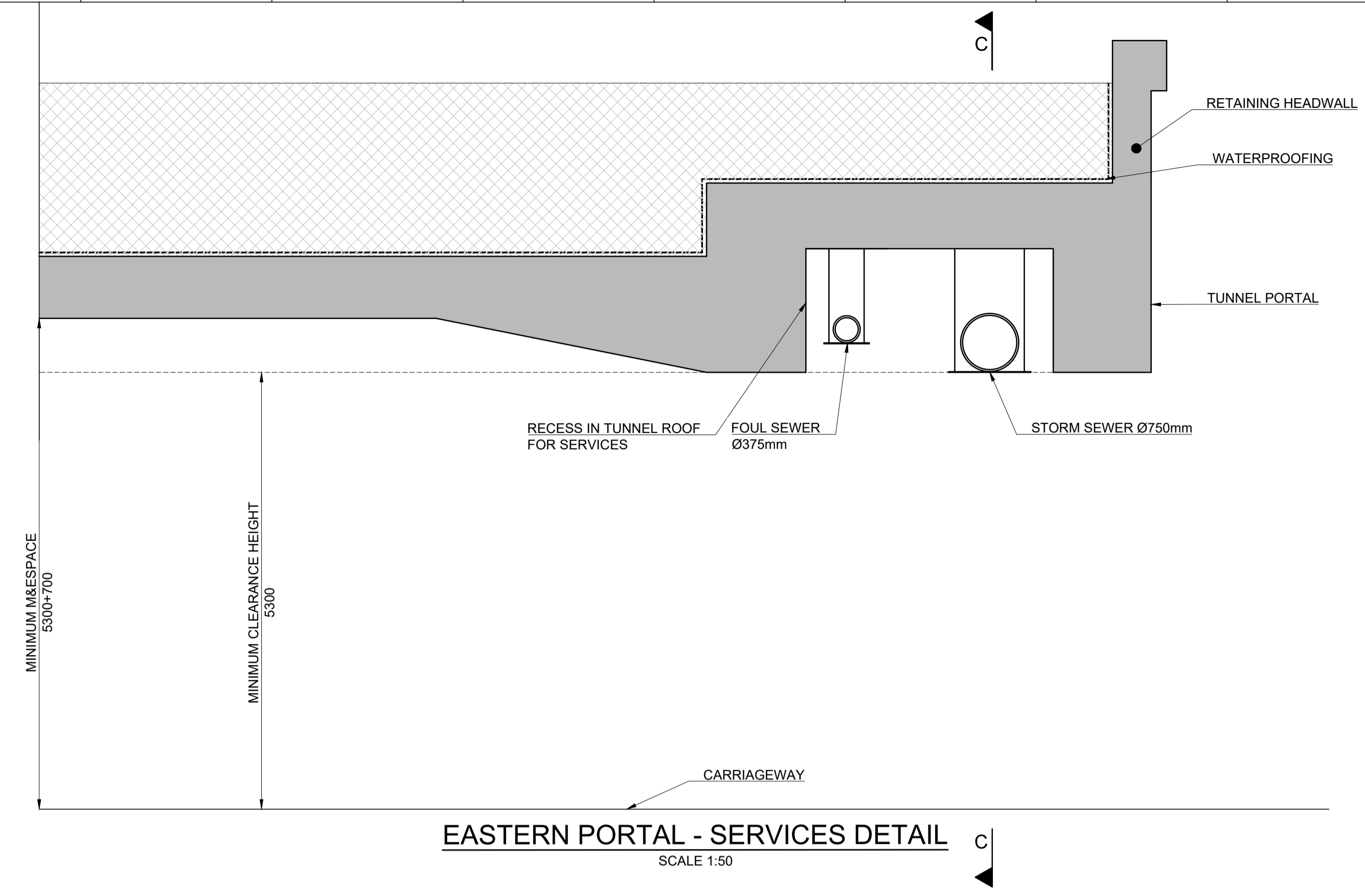

EASTERN PORTAL - SERVICES DETAIL
SCALE 1:50

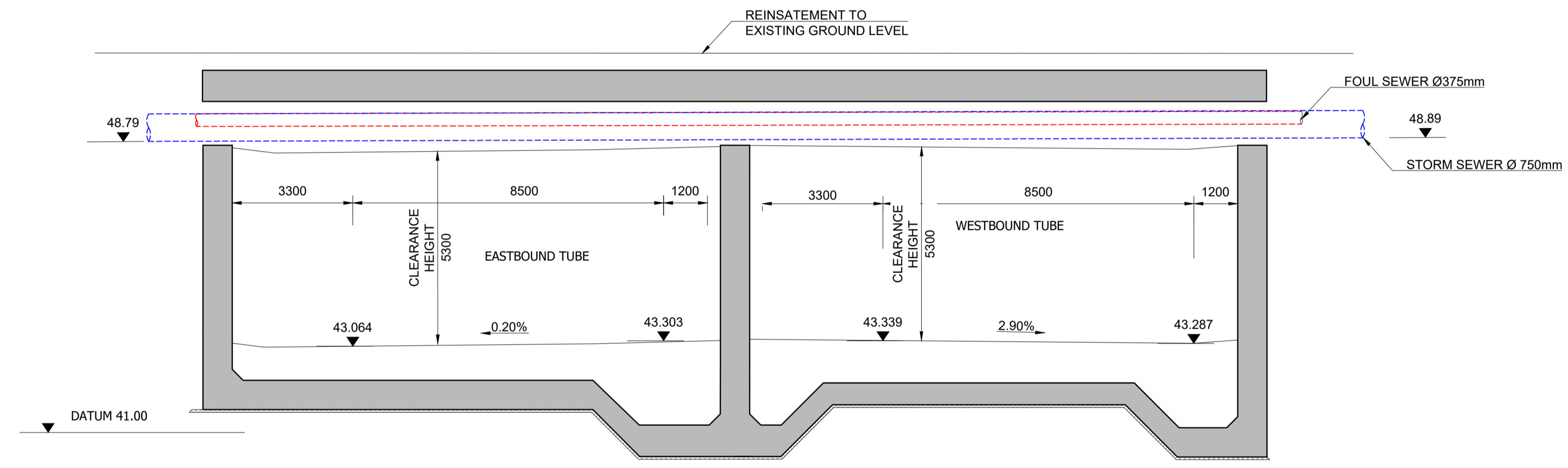

SECTION C-C
SCALE 1:100

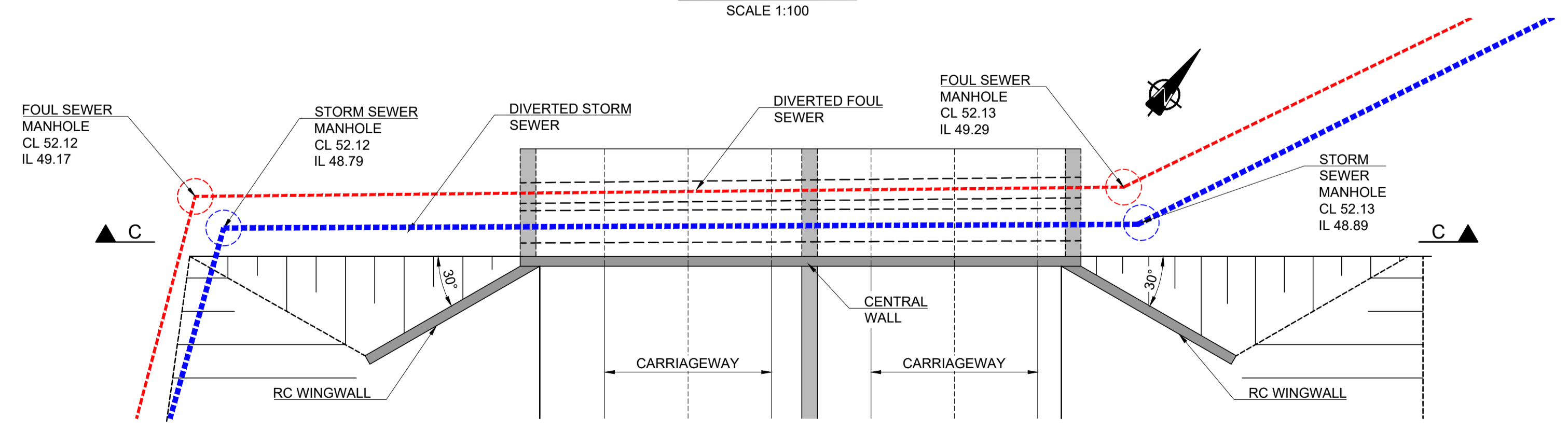

PLAN SE PORTAL- SERVICES DETAIL
SCALE 1:200

San áireamh tá sonraíocht Shuirbhíreachtí Ordánáis Éireann arna atáirgeadh faoi Cheadúnas OSI Uimh. 2010/17CCMA/Comhairle Contae na Gaillimhe. Sírúinn atáirgeadh neamhdáraithe cóipeacht Shuirbhíreachtí Ordánáis Éireann agus Rialtas na hÉireann. © Suirbhíreachtí Ordánáis Éireann, 2010.

© Suirbhíreachtí Ordánáis Éireann. Gach ceart ar chosaint. Uimhir cheadúnais 2010/17CCMA/Comhairle Contae na Gaillimhe.

Includes Ordnance Survey Ireland data reproduced under OSI Licence number 2010/17CCMA/Galway County Council. Unauthorised reproduction infringes Ordnance Survey Ireland and Government of Ireland copyright. © Ordnance Survey Ireland, 2010.

© Ordnance Survey Ireland. All rights reserved. Licence number 2010/17CCMA/Galway County Council.

Clients

Comhairle Chontae na Gaillimhe
Galway County Council

Galway City Transport Project

An Roinn Iompair Turasóireachta agus Spóirt
Department of Transport, Tourism and Sport

TIIP
Bonnagar Iompair Éireann
Transport Infrastructure Ireland

Consultant

ARUP

Corporate House
City East Business Park
Ballybrit, Galway, Ireland.

Tel +353 (0)91 460675
www.NGalwayCity.ie
www.arup.ie

Job Title

N6 Galway City Ring Road

Scale

As Noted

Date:

November 2016

Issue	Date	By	Chkd	Appd
I2	30/06/2017	LM	FB	PM
I1	02/06/2017	LM	FB	PM

Drawing Title

S14-02 Galway Racecourse Tunnel Utilities at South East Portal

Drawing Status

For Information

Job No

233985

Drawing No

GCOB-1700-D-S14-02-003

Issue

I2



X 533835.90,
Y 728086.13,
53.3

Oil storage tanks in banded enclosures (4m L x 2mØ x 2No.)

Fire water storage tanks (6mØ x 4m H x 2No.)

Parking 30 Spaces

Service Yard

Service Yard Entrance

Car Park Entrance

15+050

00+100

Disclaimer Note: The Design shown is draft only and is subject to change. More detailed assessments, ongoing studies and the information received from the public may result in changes to parts, or all of the Design. Any changes to the Design may affect the other information.

Nóta Skéama: Tá an Deiradh ina bhfoirm dréacht, d'fhéadfai athraithe teacht air. Is mar toradh ar mheasúnaithe níos mionchruinne, ar staidéir léimínach agus ar eolas ón tpubhal a bhaintí athraithe teacht ar an Deiradh ina iomláine nó ar chuid de. D'fhéadfadh ag an athrú ar an Deiradh tionchar a bheith aige ar an eolas eile.



Job Title: N6 Galway City Ring Road
Scale: 1:200 @A0
Date: June 2017

Issue	Date	By	Crkd	Appd
17	22/06/17	GOD	AJD	AJD
16	02/06/17	SK	AJD	AJD
15	24/05/17	EK	AJD	AJD
14	08/05/17	EK	AJD	AJD
13	17/02/17	EK	AJD	AJD
12	09/12/2016	SK	AJD	AJD
11	20/10/2016	SK	AJD	AJD

San áireamh tá sonraíochtaí Shuarbhreacht Ordánais Éireann agus ábharthaíocht Ordánais OS (Lamb, 2010) TCCMA Comhairle Contae na Gaillimhe. Siúlaimis ábharthaíocht nuair a bhíodas na cúlúcháir Shuarbhreacht Ordánais Éireann agus ábharthaíocht na hÉireann. ©Shuarbhreacht Ordánais Éireann, 2010.
©Shuarbhreacht Ordánais Éireann. Gach carr ar chosaint. (Under copyright 2010) TCCMA Comhairle Contae na Gaillimhe.
Includes Ordnance Survey Ireland data reproduced under OS Licence number 2010/TCCMA Galway County Council. Unauthorised reproduction infringes Ordnance Survey Ireland and Government of Ireland copyright. ©Ordnance Survey Ireland, 2010.
©Ordnance Survey Ireland. All rights reserved. Licence number 2010/TCCMA Galway County Council.

Drawing Title: Galway Racecourse Tunnel Proposed Technical Services Building
Drawing Status: For Information
Job No: 233985
Drawing No: GCOB-2700-D-1000
Issue: 17

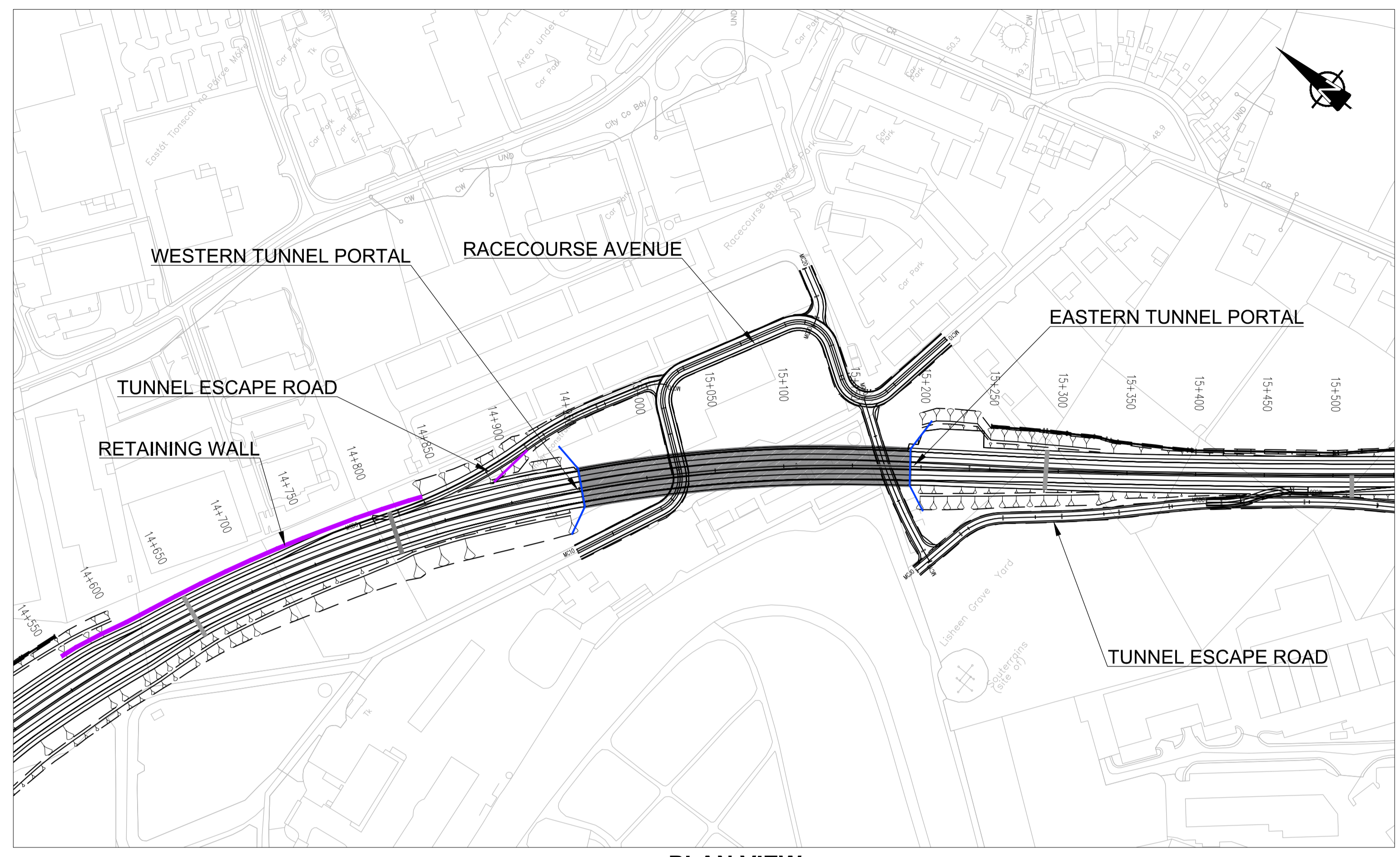

PLAN VIEW

- Legend:**
- Plan view**
- Current Design
 - Structure
 - Retaining Wall
 - Tunnel Outline
- Profile view**
- Existing Ground Level
 - Indicative Rock Level
 - Proposed Road Level
 - Tunnel Outline

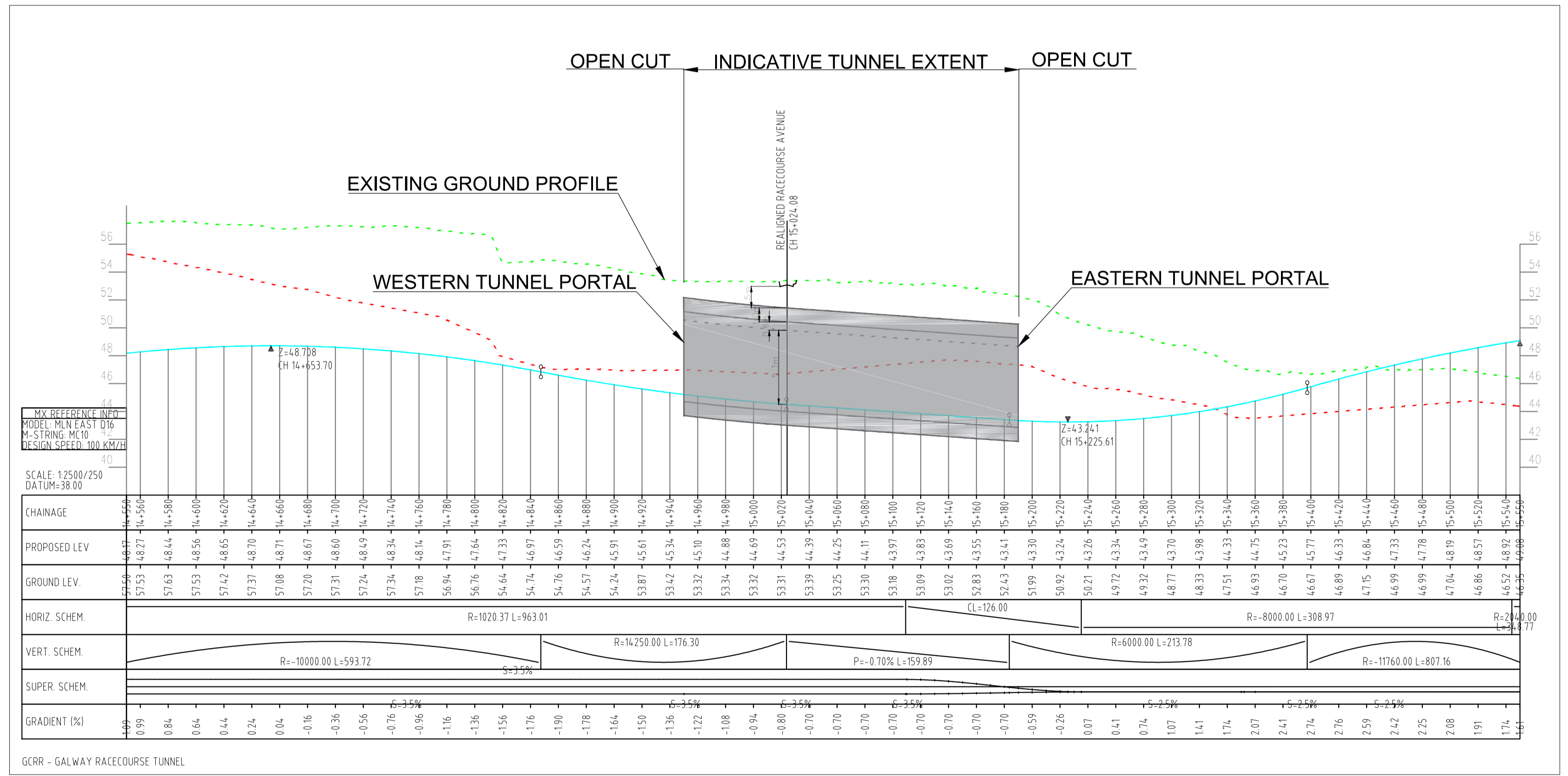

PROFILE VIEW

San áireamh tá sonraíocht Shuirbhíreacht Ordánais Éireann arna atáirgeadh faoi Cheadúnas OSI Uimh. 2010/17CCMA/Comhairle Contae na Gaillimhe. Sáraíonn atáirgeadh neamhúdaraithe cóipeacht Shuirbhíreacht Ordánais Éireann agus Rialtas na hÉireann. © Suirbhíreacht Ordánais Éireann, 2010.

© Suirbhíreacht Ordánais Éireann. Gach ceart ar chosaint. Uimh. cheadúnais 2010/17CCMA/Comhairle Contae na Gaillimhe.

Includes Ordnance Survey Ireland data reproduced under OSI Licence number 2010/17CCMA/Galway County Council. Unauthorised reproduction infringes Ordnance Survey Ireland and Government of Ireland copyright. © Ordnance Survey Ireland, 2010.

© Ordnance Survey Ireland. All rights reserved. Licence number 2010/17CCMA/Galway County Council.

Disclaimer Note:
The Design shown is draft only and is subject to change. More detailed assessments, ongoing studies and the information received from the public may result in changes to parts, or all of the Design. Any changes to the Design may affect the other information.

Nóta Sáanta:
Tá an Dearadh ina bhfoirm dréacht, d'fhéadfaí athraithe teacht air. Is mar toradh ar mheasúnaithe níos mionchruinne, ar staidéar leanúnach agus ar eolas ón gpubal a dhéanfaí athruithe teacht ar an Dearadh ina iomláine nó ar chuid de. D'fhéadfaidh ag aon athrú ar an Dearadh tionchar a bheith aige ar an eolas eile.

Clients

Comhairle Chontae na Gaillimhe
Galway County Council

Galway City Transport Project

An Roinn Iompair Turasóireachta agus Spóirt
Department Transport, Tourism and Sport

TIIP
Bonnagar Iompair Éireann
Transport Infrastructure Ireland

Consultant

ARUP

Corporate House
City East Business Park
Ballybri, Galway, Ireland.

Tel +353 (0)91 460675
www.NGalwayCity.ie
www.arup.ie

Job Title
N6 Galway City Transport Project

Scale: Plan: 1:2500 Profile: 1:2500 H / 1:250 V @ A1

Date: May 2017

Issue	Date	By	Chkd	Appd
I5	25/05/2017	GOD	MH	EMC
I4	06/12/2016	GOD	MH	EMC
I3	19/10/2016	ND	HK	EMC
I2	12/10/2016	GOD	HK	EMC
I1	18/05/2016	GOD	HK	EMC

Drawing Title
S14-02 Galway Racecourse Tunnel

Plan Profile
Alignment

Drawing Status

For Information

Job No	Drawing No	Issue
233985-00	GCOB-SK-D-674	I5

FOR INFORMATION

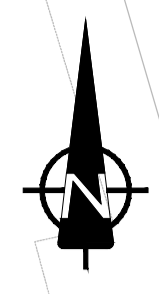

- Legend:**
- Current Design - N6 Galway City Ring Road (GCRR)
 - Proposed Foul Sewer Diversion
 - Proposed Surface Water Sewer Diversion
 - Proposed Foul Sewer
 - Proposed Foul Rising Main

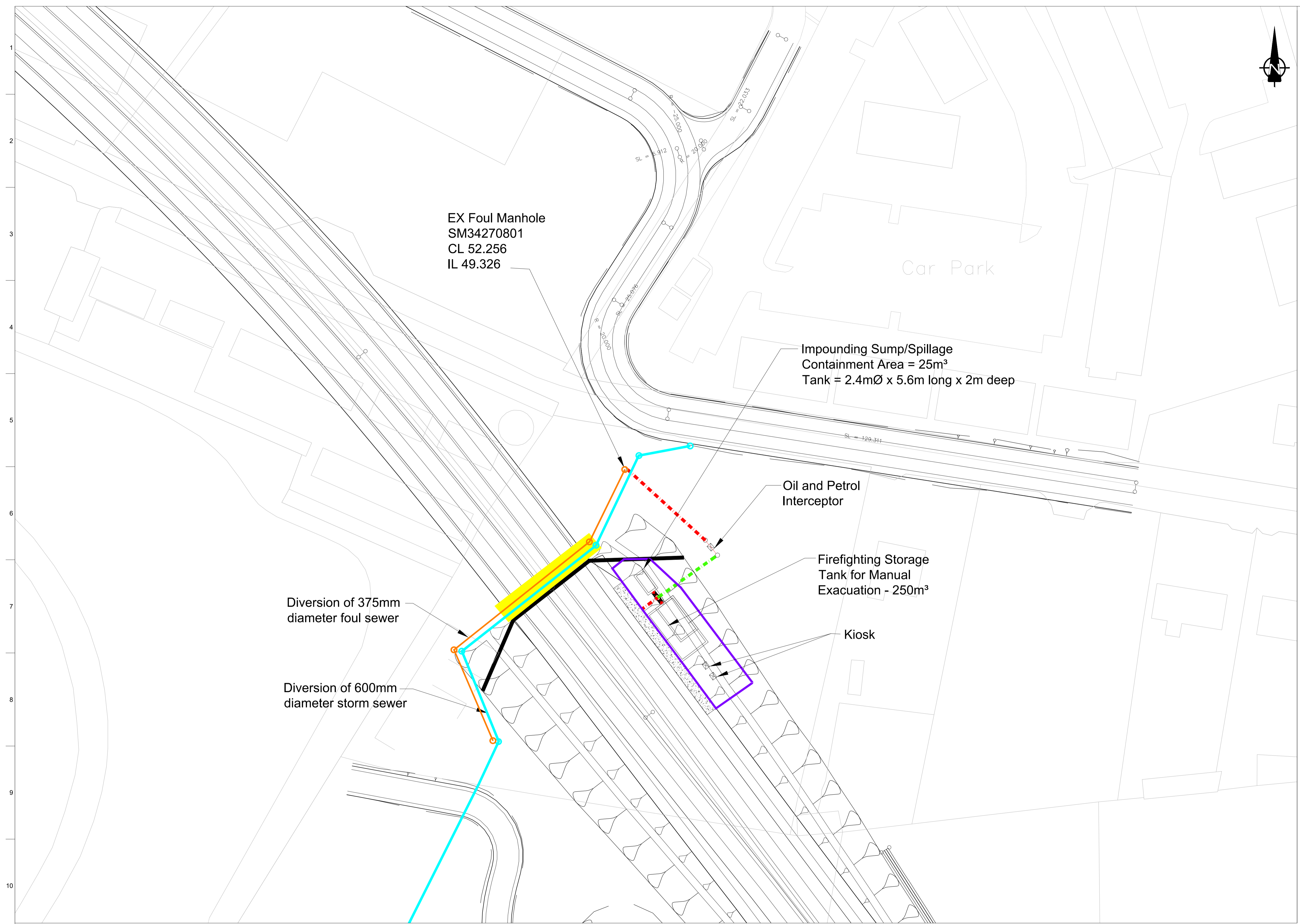

Includes Ordnance Survey Ireland data reproduced under OSI Licence number 2010/16CCMA/Galway County Council. Unauthorised reproduction infringes Ordnance Survey Ireland and Government of Ireland copyright. © Ordnance Survey Ireland, 2010.

San áireamh tá sanraíocht Shuirbhíreacht Ordánais Éireann arna atáirgeadh faoi Cheadúnas OSI Uimh. 2010/16CCMA/Comhairle Contae na Gaillimhe. Sárú ar na atáirgeadh neamhúdaraithe cóipeacht Shuirbhíreacht Ordánais Éireann agus Riailtas na hÉireann. © Suirbhíreacht Ordánais Éireann, 2010.

Disclaimer Note:
The Design shown is draft only and is subject to change. More detailed assessments, ongoing studies and the information received from the public may result in changes to parts, or all of the Design. Any changes to the Design may affect the other information.

Nóta Sáanta:
Tá an Dearadh ina bhfoirm dréacht, d'fhéadfaí athraithe teacht air. Is mar toradh ar mheasúnaithe níos mionchruinne, ar staidéar leanúnach agus ar eolas ón bpobal a dhéanfaí athruithe teacht ar an Dearadh ina iomláine nó ar chuid de. D'fhéadfaidh ag aon athrú ar an Dearadh tionchar a bheith aige ar an eolas eile.

Clients

Comhairle Chontae na Gaillimhe
Galway County Council

Galway City Transport Project

An Roinn Iompair Turasoireachta agus Spóirt

TIU

Consultant

ARUP

Corporate House
City East Business Park
Ballybri, Galway, Ireland.

Tel +353 (0)91 460675
www.N6GalwayCity.ie
www.arup.ie

Job Title
N6 Galway City Ring Road

Scale
1:1000 @ A1 / 1:2000 @ A3

Date:
Jan 2017

Issue	Date	By	Chkd	Appd
I1	06/01/2017	IA	EMC	EMC

Drawing Title
Galway Racecourse Tunnel
Proposed Sump Location and
Sewer Diversion

Drawing Status

For Information

Job No	Drawing No	Issue
233985-00	GCOB-SK-D-809	I1

Appendix B

Geotechnical factual report

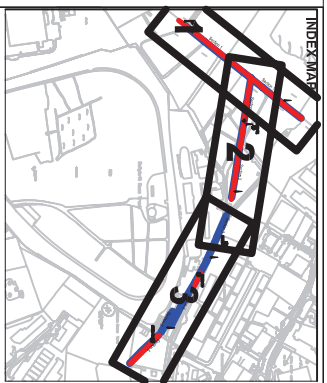
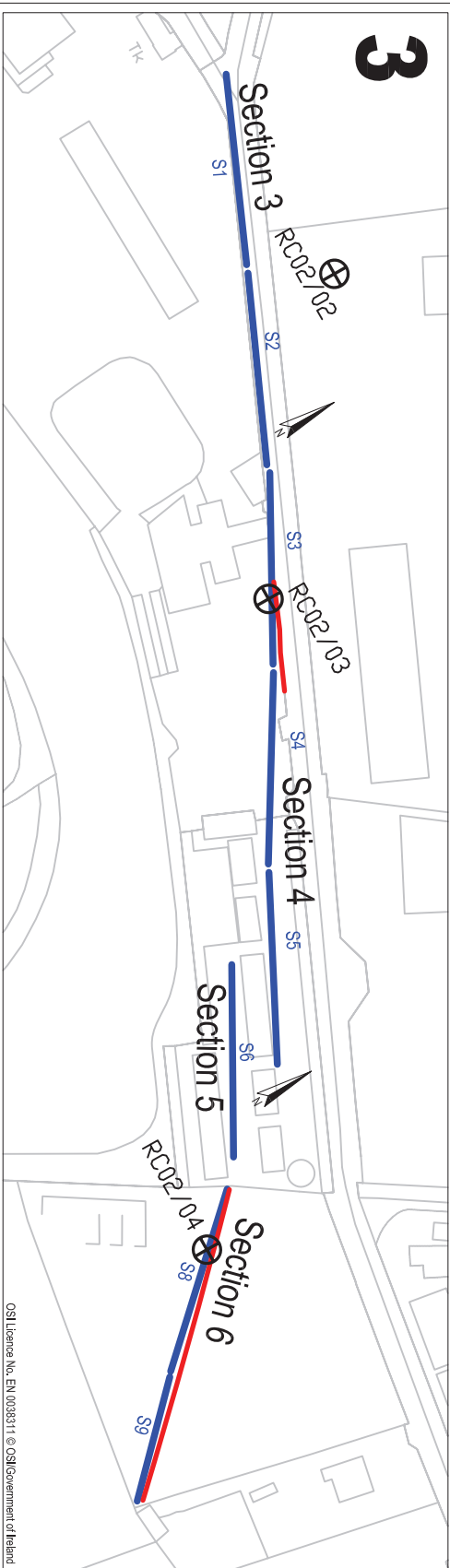
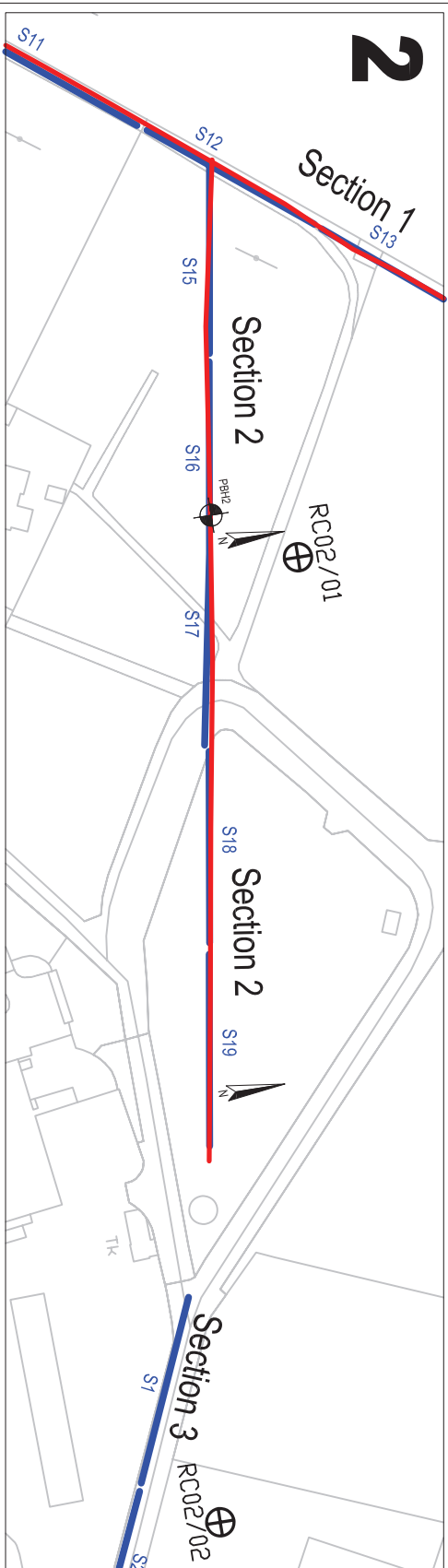
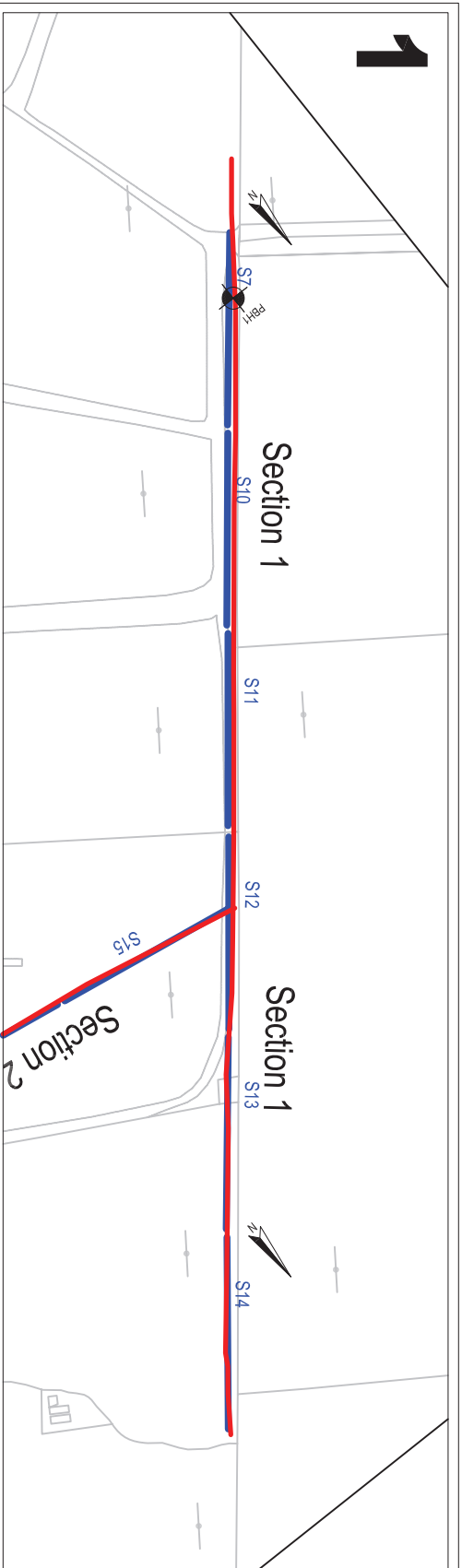

- LEGEND:**
- RT Electrical Resistivity Tomography
 - S1 Seismic refraction profile
 - ⊕ RC02/01 Rotary Cored Boreholes
 - ⊕ APEX Proposed borehole



6 Knockmullen Business Park, Regus House, Herald Way
 Gorey,
 Co. Wexford
 Ireland.
 T +353 (0)402-21842
 F +353 (0)402-21843
 E info@apexgeoservices.ie
 www.apexgeoservices.ie

PROJECT: N6 Galway City Transport Project, Phase 2
 Geophysical Survey

DRAWING No.: AGL15188_01

DATE: 09-10-2015

CLIENT: ARUP

SCALE: 1:2500 @ A4

Version:	Date:	Drawn By:	Checked:
01	09-10-15	YOC	
02	23-11-15	YOC	



GEOTECHNICAL CORE LOG RECORD

REPORT NUMBER

18746

CONTRACT N6 Galway Transport Project (Phase 2)		DRILLHOLE NO RC02/02
CO-ORDINATES 533,684.92 E 728,102.47 N		SHEET Sheet 1 of 2
GROUND LEVEL (mOD) 54.92	RIG TYPE Knebel	DATE DRILLED 16/10/2015
CLIENT Galway County Council	FLUSH Air/Mist	DATE LOGGED 20/10/2015
ENGINEER ARUP	INCLINATION (deg) -90	DRILLED BY IGSL
	CORE DIAMETER (mm) 80	LOGGED BY K.Kinsella

Downhole Depth (m)	Core Run Depth (m)	T.C.R.%	S.C.R.%	R.Q.D.%	Fracture Spacing Log (mm)	Non-intact Zone	Legend	Description	Depth (m)	Elevation	Standpipe Details	SPT (N Value)
0								SYMMETRIX DRILLING: No recovery- Driller reports MADE GROUND consisting of gravel.	0.50	54.42		
1								SYMMETRIX DRILLING: No recovery- Driller reports sandy cobbly clay.	1.50	53.42		
2								SYMMETRIX DRILLING: No recovery- Driller reports sandy gravelly clay.				
3												
4												
5												
6									6.00	48.92		
6.50	52	0	0					Gravel and Cobbles - Possible weathered rock	6.50	48.42		
7								SYMMETRIX DRILLING: No recovery- Driller reports sandy gravelly clay - possible weathered rock				
7.30	0	0	0						7.30	47.62		
7.90	95	43	43					Strong to very strong, thick to very thin bedded, light to dark grey, fine to medium grained, LIMESTONE (localised chert and stylolites), fresh to moderately weathered (7.38-7.50m, 8.75-9.16m) with slight solution weathered.				
8.75	100	46	38					Discontinuities are medium to closely spaced, rough to locally smooth, planar to locally undulose. Apertures are tight to moderately open, clayed and gravel filled, locally calcite veined (5mm). Dips are sub-horizontal with very locally vertical.				
9.30	100	29	29									
9.60	100	53	33									
9.85	100	100	68									

REMARKS Hole cased 0.00-7.30m					WATER STRIKE DETAILS				
					Water Strike	Casing Depth	Sealed At	Rise To	Time (min)
					No water strike recorded				
INSTALLATION DETAILS					GROUNDWATER DETAILS				
					Date	Hole Depth	Casing Depth	Depth to Water	Comments
20-10-15	19.90	12.00	19.90	50mm SP					

IGSL RC F1 10M 18746.GPJ IGSL.GDT 19/11/15



GEOTECHNICAL CORE LOG RECORD

REPORT NUMBER

18746

CONTRACT N6 Galway Transport Project (Phase 2)

DRILLHOLE NO RC02/02
SHEET Sheet 2 of 2

CO-ORDINATES 533,684.92 E
728,102.47 N
GROUND LEVEL (mOD) 54.92

RIG TYPE Knebel
FLUSH Air/Mist
INCLINATION (deg) -90
CORE DIAMETER (mm) 80

DATE DRILLED 16/10/2015
DATE LOGGED 20/10/2015

CLIENT ENGINEER Galway County Council
ARUP

DRILLED BY IGSL
LOGGED BY K.Kinsella

Downhole Depth (m)	Core Run Depth (m)	T.C.R.%	S.C.R.%	R.Q.D.%	Fracture Spacing Log (mm)	Non-intact Zone	Legend	Description	Depth (m)	Elevation	Standpipe Details	SPT (N Value)
10		99	97	90				Strong to very strong, thick to very thinly bedded, light to dark grey, fine to medium grained, LIMESTONE (localised chert and stylolites), fresh to moderately weathered (7.38-7.50m, 8.75-9.16m) with slight solution weathered.				
11.00							Discontinuities are medium to closely spaced, rough to locally smooth, planar to locally undulose. Apertures are tight to moderately open, clayed and gravel filled, locally calcite veined (5mm). Dips are sub-horizontal with very locally vertical. <i>(continued)</i>					
11		100	95	52								
11.80												
12		100	84	69								
12.25												
13		100	87	69								
13.75												
14		100	49	49								
14.50												
14.75		100	80	80								
15												
15.85		98	79	63								
16												
16		100	97	82								
17												
17.35												
18		100	96	59								
18.25												
18.85		100	100	75								
19												
19		97	73	61								
19.90									19.90	35.02		

REMARKS End of Borehole at 19.90 m

Hole cased 0.00-7.30m	WATER STRIKE DETAILS					
	Water Strike	Casing Depth	Sealed At	Rise To	Time (min)	Comments
						No water strike recorded

GROUNDWATER DETAILS									
INSTALLATION DETAILS									
Date	Tip Depth	RZ Top	RZ Base	Type	Date	Hole Depth	Casing Depth	Depth to Water	Comments
20-10-15	19.90	12.00	19.90	50mm SP					

IGSL RC F1 10M 18746.GPJ IGSL.GDT 19/11/15



GEOTECHNICAL CORE LOG RECORD

REPORT NUMBER

18746

CONTRACT N6 Galway Transport Project (Phase 2)

DRILLHOLE NO RC02/03
SHEET Sheet 1 of 2

CO-ORDINATES 533,774.69 E
728,024.34 N
GROUND LEVEL (mOD) 53.89

RIG TYPE Knebel
FLUSH Air/Mist
INCLINATION (deg) -90
CORE DIAMETER (mm) 80

DATE DRILLED 12/10/2015
DATE LOGGED 14/10/2015

CLIENT ENGINEER Galway County Council
ARUP

DRILLED BY IGSL
LOGGED BY K.Kinsella

Downhole Depth (m)	Core Run Depth (m)	T.C.R.%	S.C.R.%	R.Q.D.%	Fracture Spacing Log (mm)	Non-intact Zone	Legend	Description	Depth (m)	Elevation	Standpipe Details	SPT (N Value)
0								SYMMETRIX DRILLING: No recovery- Driller reports sandy clay with occasional gravel.				
1								SYMMETRIX DRILLING: No recovery- Driller reports sandy gravelly clay.	1.20	52.69		
2												
3												
4												
4.50								Firm, light to dark brown, sandy CLAY. Sand is fine to coarse.	4.50	49.39		
5.00	40	0	0									
6												
6.50	27	0	0						6.50	47.39		
7												
7.00	0	0	0					SYMMETRIX DRILLING: No recovery- Driller reports sandy gravelly clay - possible weathered rock	7.00	46.89		
7.60	67	25	25					Strong to very strong, thick to very thin bedded, light to dark grey, locally very fractured (7.00-7.60m, 9.10-9.20m), with a light brown clay infill, fine to medium grained, LIMESTONE (localised stylolites and chert), fresh to locally moderately weathered (9.20-9.53m, 12.28-12.71m).				
8								Discontinuities are wide to closely spaced, rough, planar to locally undulose. Apertures are tight to moderately open, stiff light to dark brown sand and clay infill, locally calcite veined (2-15mm) and iron-oxide stained. Dips are sub-horizontal, two vertical (18.30-18.60m and 18.93-19.34m).				
9												
9.10	100	91	91									
9.20	100	0	0									
	100	80	75									

REMARKS
Hole cased 0.00-6.00m

WATER STRIKE DETAILS

Water Strike	Casing Depth	Sealed At	Rise To	Time (min)	Comments
					No water strike recorded

GROUNDWATER DETAILS

INSTALLATION DETAILS

Date	Hole Depth	Casing Depth	Depth to Water	Comments

IGSL RC F1 10M 18746.GPJ IGSL.GDT 19/11/15



GEOTECHNICAL CORE LOG RECORD

REPORT NUMBER

18746

CONTRACT N6 Galway Transport Project (Phase 2)		DRILLHOLE NO RC02/03
CO-ORDINATES 533,774.69 E 728,024.34 N		SHEET Sheet 2 of 2
GROUND LEVEL (mOD) 53.89	RIG TYPE Knebel	DATE DRILLED 12/10/2015
CLIENT Galway County Council	FLUSH Air/Mist	DATE LOGGED 14/10/2015
ENGINEER ARUP	INCLINATION (deg) -90	DRILLED BY IGSL
	CORE DIAMETER (mm) 80	LOGGED BY K.Kinsella

Downhole Depth (m)	Core Run Depth (m)	T.C.R.%	S.C.R.%	R.Q.D.%	Fracture Spacing Log (mm)	Non-intact Zone	Legend	Description	Depth (m)	Elevation	Standpipe Details	SPT (N Value)	
10								<p>Strong to very strong, thick to very thinly bedded, light to dark grey, locally very fractured (7.00-7.60m, 9.10-9.20m), with a light brown clay infill, fine to medium grained, LIMESTONE (localised stylolites and chert), fresh to locally moderately weathered (9.20-9.53m, 12.28-12.71m).</p> <p>Discontinuities are wide to closely spaced, rough, planar to locally undulose. Apertures are tight to moderately open, stiff light to dark brown sand and clay infill, locally calcite veined (2-15mm) and iron-oxide stained. Dips are sub-horizontal, two vertical (18.30-18.60m and 18.93-19.34m). <i>(continued)</i></p>					
10.60													
11		100	76	50									
11.30													
11.80		100	100	100									
12		95	70	70									
12.20													
12.80		83	30	0									
13		100	71	71									
13.15													
13.80		100	74	57									
14		100	96	96									
14.30													
15		93	91	91									
15.30													
16		97	97	92									
16.80													
17		83	80	63									
17.10													
18		96	92	89									
18.30													
18.60		93	93	93									
19													
19		94	89	86									
20.00									20.00	33.89			

REMARKS End of Borehole at 20.00 m								WATER STRIKE DETAILS						
Hole cased 0.00-6.00m								Water Strike	Casing Depth	Sealed At	Rise To	Time (min)	Comments	
													No water strike recorded	
								GROUNDWATER DETAILS						
INSTALLATION DETAILS								Date	Hole Depth	Casing Depth	Depth to Water	Comments		
Date	Tip Depth	RZ Top	RZ Base	Type										

IGSL RC.FI.10M 18746.GPJ IGSL.GDT 19/11/15



GEOTECHNICAL CORE LOG RECORD

REPORT NUMBER

18746

CONTRACT N6 Galway Transport Project (Phase 2)		DRILLHOLE NO RC02/04
		SHEET Sheet 1 of 3
CO-ORDINATES 533,966.82 E 727,889.85 N	RIG TYPE Knebel FLUSH Air/Mist	DATE DRILLED 14/10/2015
GROUND LEVEL (mOD) 52.27		DATE LOGGED 14/10/2015
CLIENT Galway County Council	INCLINATION (deg) -90	DRILLED BY IGSL
ENGINEER ARUP		LOGGED BY K.Kinsella
		CORE DIAMETER (mm) 80

Downhole Depth (m)	Core Run Depth (m)	T.C.R.%	S.C.R.%	R.Q.D.%	Fracture Spacing Log (mm)	Non-intact Zone	Legend	Description	Depth (m)	Elevation	Standpipe Details	SPT (N Value)
0								SYMMETRIX DRILLING: No recovery- Driller reports sandy clay.				
1												
2								SYMMETRIX DRILLING: No recovery- Driller reports sandy gravelly clay.	1.80	50.47		
3												
4												
5								SYMMETRIX DRILLING: No recovery- Driller reports limestone.	4.80	47.47		
5.40									5.40	46.87		
6.00	100	95	67					Strong to very strong, medium to very thinly bedded, light to dark grey, locally very fractured, fine to medium grained, LIMESTONE (localised stylolites and chert), fresh to locally slightly weathered with slight solution weathering.				
6.64	100	97	80					Discontinuities are medium to closely spaced, smooth to locally rough, planar to locally undulose. Apertures are tight to moderately open, very firm mottled brown/grey clay infill (10.67-10.90m), calcite veined (1mm), iron-oxide stained. Dips are sub-horizontal to very locally sub-vertical.				
7	99	91	86									
7.55												
8	100	100	82									
8.20												
8.95	97	93	75									
9												
	100	97	89									

REMARKS Hole cased 0.00-5.40m					WATER STRIKE DETAILS					
					Water Strike	Casing Depth	Sealed At	Rise To	Time (min)	Comments
					No water strike recorded					
					GROUNDWATER DETAILS					
INSTALLATION DETAILS					Date	Hole Depth	Casing Depth	Depth to Water	Comments	
Date	Tip Depth	RZ Top	RZ Base	Type						

IGSL RC F1 10M 18746.GPJ IGSL.GDT 19/11/15



GEOTECHNICAL CORE LOG RECORD

REPORT NUMBER

18746

CONTRACT N6 Galway Transport Project (Phase 2)		DRILLHOLE NO RC02/04
CO-ORDINATES 533,966.82 E 727,889.85 N		SHEET Sheet 2 of 3
GROUND LEVEL (mOD) 52.27	RIG TYPE Knebel	DATE DRILLED 14/10/2015
CLIENT Galway County Council	FLUSH Air/Mist	DATE LOGGED 14/10/2015
ENGINEER ARUP	INCLINATION (deg) -90	DRILLED BY IGSL
	CORE DIAMETER (mm) 80	LOGGED BY K.Kinsella

Downhole Depth (m)	Core Run Depth (m)	T.C.R.%	S.C.R.%	R.Q.D.%	Fracture Spacing Log (mm)	Non-intact Zone	Legend	Description	Depth (m)	Elevation	Standpipe Details	SPT (N Value)
10								<p>Strong to very strong, medium to very thinly bedded, light to dark grey, locally very fractured, fine to medium grained, LIMESTONE (localised stylolites and chert), fresh to locally slightly weathered with slight solution weathering.</p> <p>Discontinuities are medium to closely spaced, smooth to locally rough, planar to locally undulose. Apertures are tight to moderately open, very firm mottled brown/grey clay infill (10.67-10.90m), calcite veined (1mm), iron-oxide stained. Dips are sub-horizontal to very locally sub-vertical. <i>(continued)</i></p>				
10.45												
10.90	100	33	33									
11												
11.95	100	94	88									
12												
13												
13.45												
14												
14.95	100	99	80									
15												
15.95	96	95	90									
16												
16.45	100	100	100									
17												
17.95	97	93	93									
18												
18.25	100	100	100									
19												
19.45	100	100	100									

REMARKS Hole cased 0.00-5.40m					WATER STRIKE DETAILS				
					Water Strike	Casing Depth	Sealed At	Rise To	Time (min)
					No water strike recorded				
					GROUNDWATER DETAILS				
INSTALLATION DETAILS					Date	Hole Depth	Casing Depth	Depth to Water	Comments
Date	Tip Depth	RZ Top	RZ Base	Type					

IGSL RC Fl 10M 18746.GPJ IGSL.GDT 19/11/15

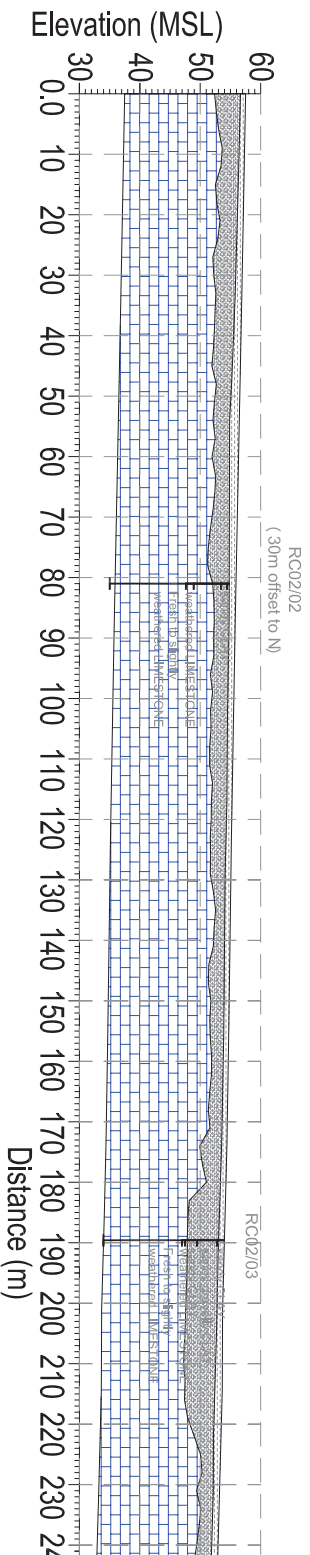
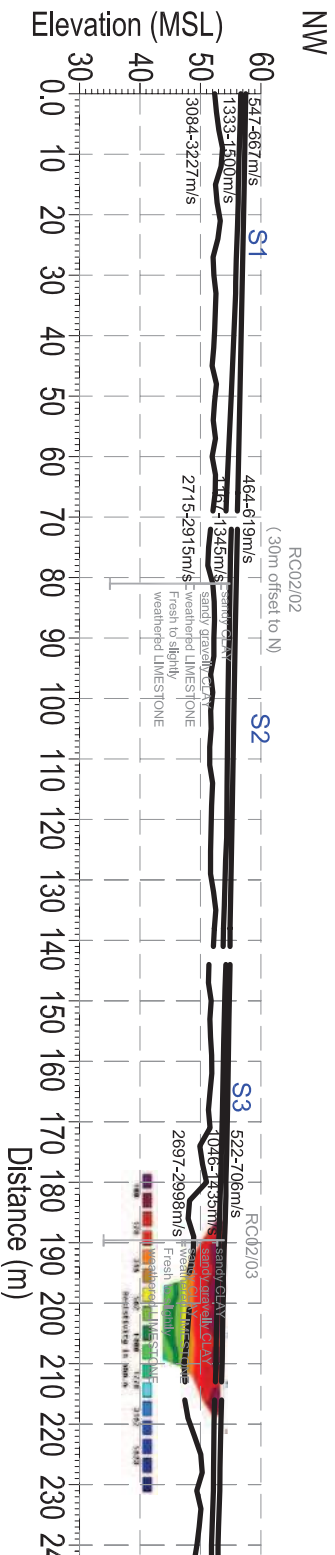
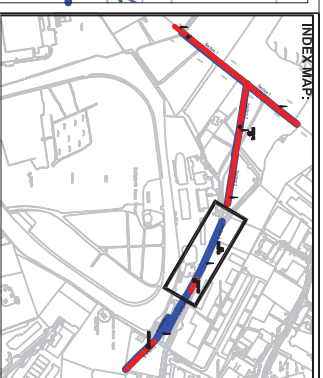
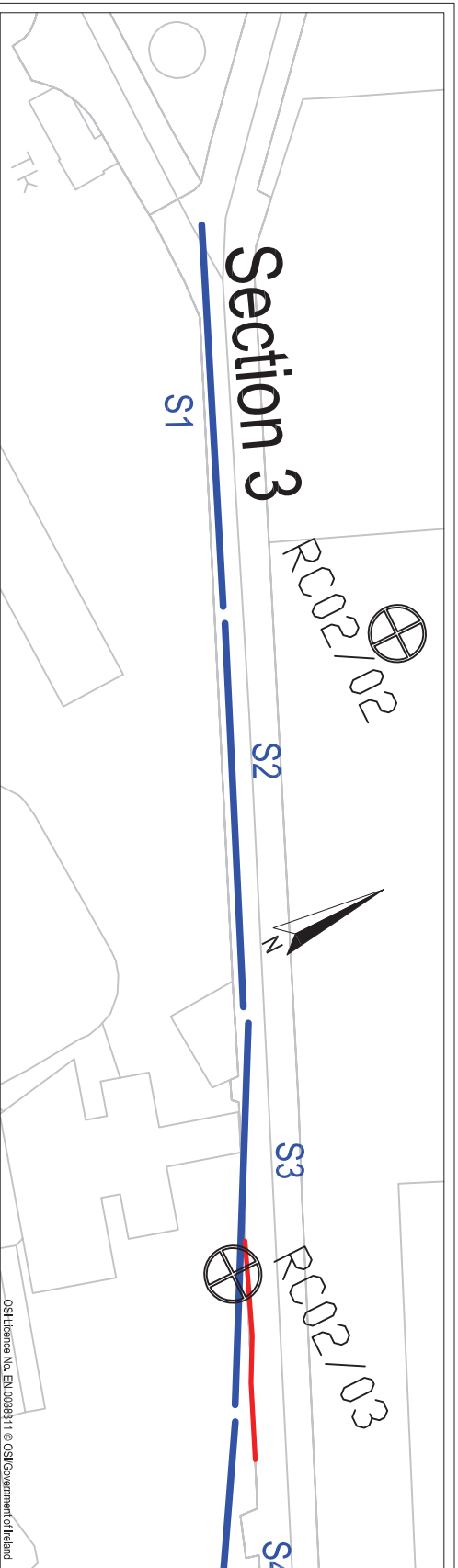

LEGEND:

- Electrical Resistivity Tomography
- Seismic refraction profile
- Rotary Cored Boreholes
- APEX Proposed borehole
- Firm-silt or medium dense to dense OVERBURDEN
- Silt-very silt or dense to very dense OVERBURDEN or moderately weathered BEDROCK
- Slight weathered to fresh BEDROCK



6 Knockmullen Business Park, Regus House, Herald Way
Gorey, Pegasus Business Park
Co. Wexford, Castle Donington
Ireland, Derby DE74 2TZ

T +353 (0)402-21842
F +353 (0)402-21843
E info@apexgeoservices.ie
www.apexgeoservices.ie

T +44 (0)1844 8700 692
E info@apexgeoservices.co.uk
www.apexgeoservices.co.uk

PROJECT: N6 Galway City Transport Project, Phase 2
Geophysical Survey

DRAWING No.: AGL15188_06
DATE: 08-10-2015
CLIENT: ARUP
SCALE: 1:1250 @ A4

Version:	Date:	Drawn By:	Checked:
01	09-10-15	YOC	
02	23-11-15	YOC	

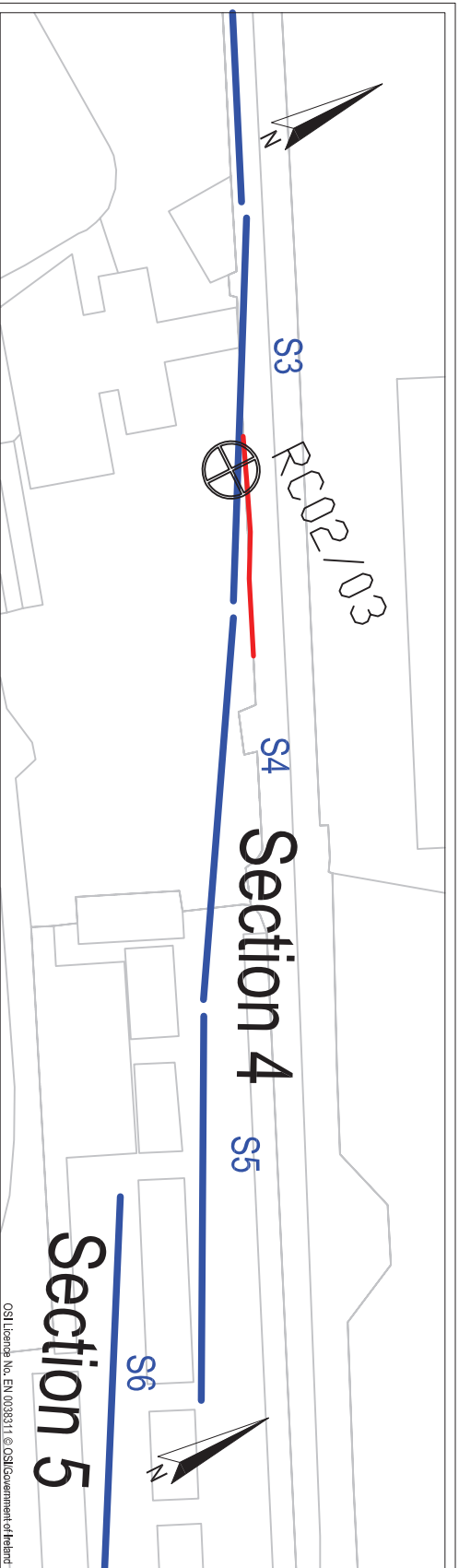

OSL Licence No. EN 0038311 © OS/Government of Ireland

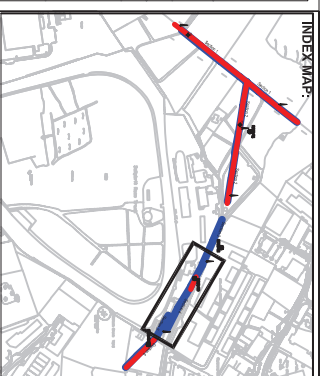
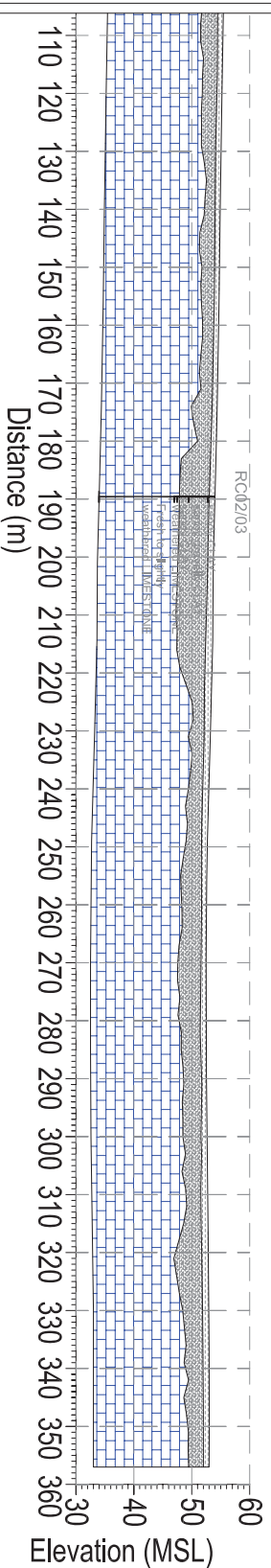
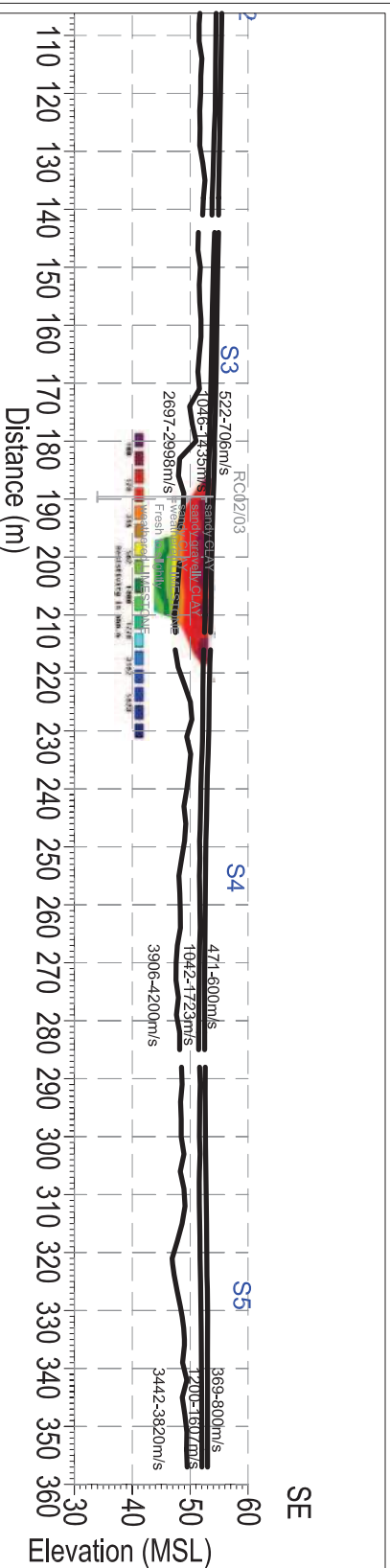

- LEGEND:**
- R1 Electrical Resistivity Tomography
 - S1 Seismic refraction profile
 - ⊗ RC02/01 Rotary Cored Boreholes
 - ⊕ APEX Proposed borehole

- Firm-silt or medium dense to dense OVERBURDEN
- Silt/very silt or dense to very dense OVERBURDEN or moderately weathered BEDROCK
- Slight weathered to fresh BEDROCK



6 Knockmullen Business Park
Regus House, Herald Way
Gorey
Co. Wexford
Castle Donington
Derby DE74 2TZ
Ireland
T +353 (0)402-21942
F +353 (0)402-21943
E info@apexgeoservices.ie
www.apexgeoservices.ie

PROJECT: N6 Galway City Transport Project, Phase 2
Geophysical Survey

DRAWING No.: AGL15188_07
DATE: 09-10-2015



CLIENT: ARUP

SCALE: 1:1250 @ A4

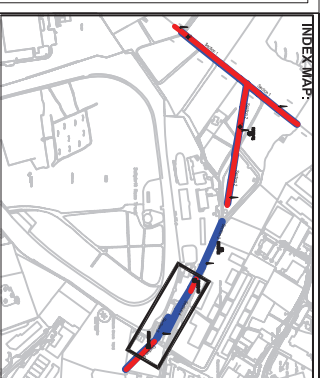
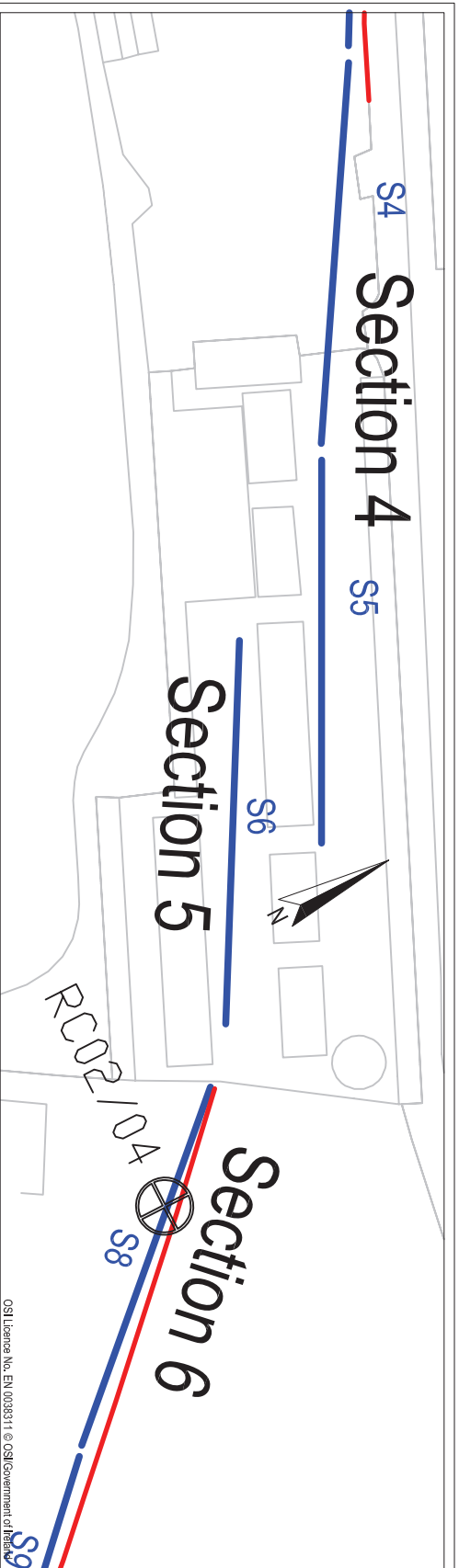
Version:	Date:	Drawn By:	Checked:
01	09-10-15	YOC	
02	23-11-15	YOC	



LEGEND:

- R1 Electrical Resistivity Tomography
- S1 Seismic refraction profile
- RC02/01 Rotary Cored Boreholes
- ⊗ PPH1 APEX Proposed borehole
-  Firm-stiff or medium dense to dense OVERBURDEN
-  Stiff-very stiff or dense to very dense OVERBURDEN or moderately weathered BEDROCK
-  Slight weathered to fresh BEDROCK

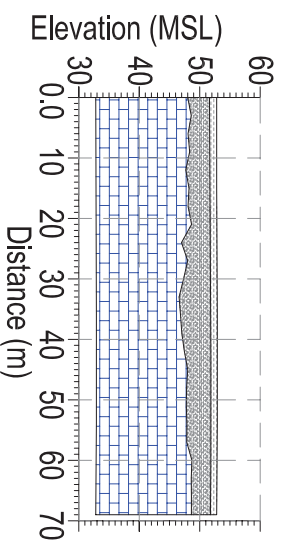
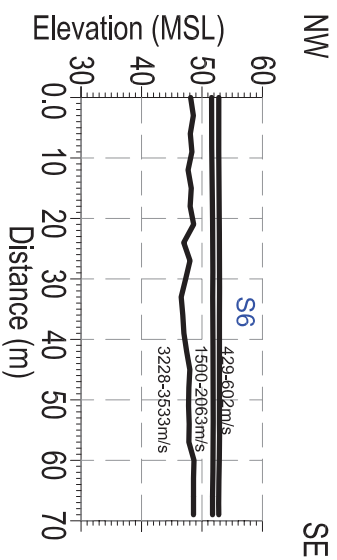

6 Knockmullen Business Park
Regus House, Herald Way
Gorey
Co. Wexford
Castle Donington
Ireland.
T +353 (0)402-21842
F +353 (0)402-21843
E info@apexgeoservices.ie
www.apexgeoservices.ie

PROJECT: N6 Galway City Transport Project, Phase 2
Geophysical Survey

DRAWING No.: AGL15188_08

DATE: 08-10-2015

CLIENT: ARUP

SCALE: 1:1250 @ A4

Version	Date	Drawn By	Checked
01	09-10-15	YOC	
02	23-11-15	YOC	

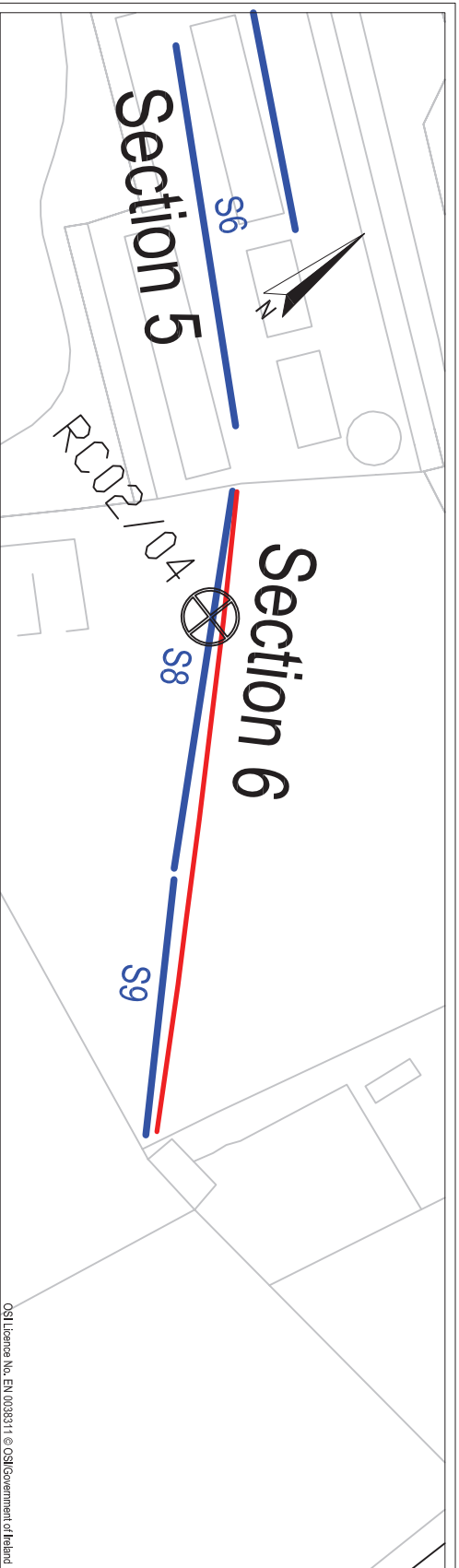

OS Licence No. EN 0038311 © OS/Government of Ireland

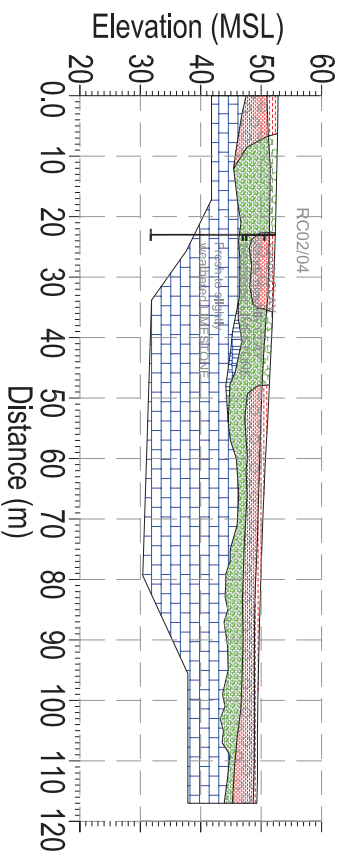
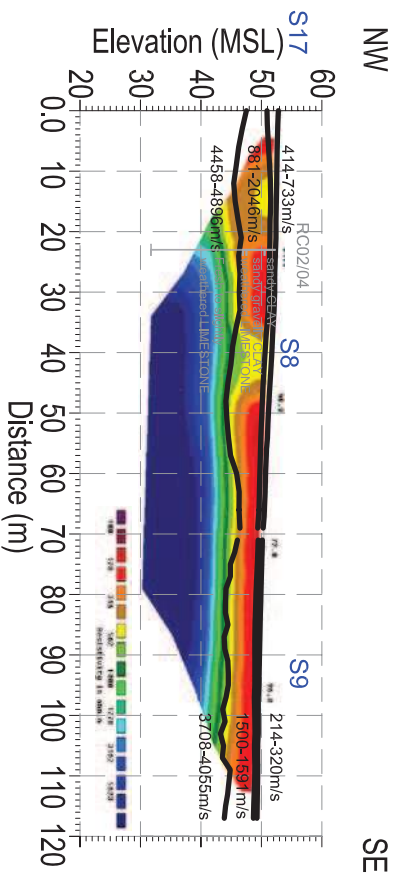
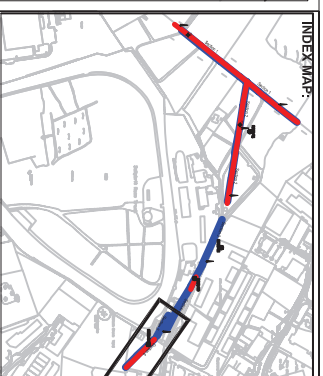

6 Knockmullen Business Park
Regus House, Herald Way
Gorey
Co. Wexford
Castle Donington
Ireland.
T +353 (0)402-21842
F +353 (0)402-21843
E info@apexgeoservices.ie
www.apexgeoservices.ie

PROJECT: N6 Galway City Transport Project, Phase 2
Geophysical Survey

DRAWING No.: AGL15188_09

DATE: 09-10-2015

CLIENT: ARUP

SCALE: 1:1250 @ A4

Version:	Date:	Drawn By:	Checked:
01	09-10-15	YOC	
02	23-11-15	YOC	



TRIAL PIT RECORD

REPORT NUMBER

18963

CONTRACT N6 Galway City Transport Project - Phase 3		TRIAL PIT NO. TP3/44
LOGGED BY A.Chryst		SHEET Sheet 1 of 1
CO-ORDINATES 533,740.76 E 728,060.11 N		DATE STARTED 19/04/2016
GROUND LEVEL (m) 54.81		DATE COMPLETED 19/04/2016
CLIENT ENGINEER Galway County Council ARUP	EXCAVATION METHOD Hitachi Zaxis 80	

Depth (m)	Geotechnical Description	Legend	Depth (m)	Elevation	Water Strike	Samples			Vane Test (KPa)	Hand Penetrometer (KPa)
						Sample Ref	Type	Depth		
0.0	GRAVEL surface dressing - Possible Cl.804 (MADE GROUND) Angular to subangular COBBLES of crushed stone with occasional fragments of concrete and red brick (MADE GROUND)		0.15	54.66						
1.0	Firm light brown slightly sandy slightly gravelly SILT/CLAY with a high cobble content. Cobbles are of limestone.		0.80	54.01		AA49493 AA49494 AA49495	B B D	1.00 1.00 1.00		
2.0	Stiff to very stiff light brown grey slightly sandy slightly gravelly CLAY with a high cobble content. Cobbles are of limestone.		1.80	53.01		AA49496 AA49497 AA49498	B B D	2.00 2.00 2.00		
2.50	End of Trial Pit at 2.50m		2.50	52.31						

Groundwater Conditions
Dry

Stability
Good

General Remarks
Pit terminated at 2.50m due to very slow progress



TRIAL PIT RECORD

REPORT NUMBER

18963

CONTRACT N6 Galway City Transport Project - Phase 3		TRIAL PIT NO. TP3/45
LOGGED BY A.Chryst		SHEET Sheet 1 of 1
CO-ORDINATES 533,837.88 E 728,015.11 N		DATE STARTED 19/04/2016
GROUND LEVEL (m) 53.28		DATE COMPLETED 19/04/2016
CLIENT ENGINEER Galway County Council ARUP	EXCAVATION METHOD Hitachi Zaxis 80	

Depth (m)	Geotechnical Description	Legend	Depth (m)	Elevation	Water Strike	Samples			Vane Test (KPa)	Hand Penetrometer (KPa)
						Sample Ref	Type	Depth		
0.0	GRAVEL surface dressing - Possible Cl.804 (MADE GROUND) Angular to subangular COBBLES of crushed stone with occasional fragments of concrete and boulders of limestone (MADE GROUND)		0.15	53.13						
1.0	Soft to firm light brown slightly sandy slightly gravelly SILT/CLAY with a high cobble and low to medium boulder content. Cobbles and boulders are of limestone.		1.20	52.08		AA43051 AA43052 AA43053	B B D	1.50 1.50 1.50		
2.0	Stiff to very stiff light brown grey slightly sandy slightly gravelly SILT/CLAY with a high cobble and low to medium boulder content. Cobbles and boulders are of limestone.		2.20	51.08		AA43054 AA43055 AA43056	B B D	2.50 2.50 2.50		
3.0	End of Trial Pit at 3.00m		3.00	50.28						

Groundwater Conditions
Dry

Stability
Good

General Remarks
Pit terminated at 3.0m due to very slow progress